



BAUMSCHEIBEN LEVEL 2

Singular quality and character.



.hess



HESS TREE GRATES – MORE THAN JUST TREE PROTECTION

Damp weather conditions usually cause a film of moisture to build up on tree grates that freezes at lower temperatures, representing a threat to the safety of pedestrians and motor vehicle drivers.

Hess's LEVEL2 tree grates all come with a anti-slip surface finish that significantly improves safety and superbly harmonises with the tree grates' outstanding design.

LEVEL2 TREE GRATES



VERONA
P.12



PICENO
P.16



MARINO
P.20



PADOVA
P.26

HAND CAST TREE GRATES

Manual workmanship with tradition, superior quality and optical brilliance. The high quality surface texture of Hess's hand moulded tree grates, cast using furan resin, lends them an unmistakable character.



VINCENZE
P. 30



MONZA
P. 36

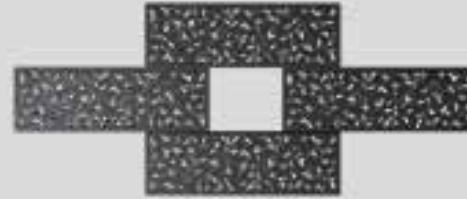

PICENO VARIO
P. 40

TREE GRATES

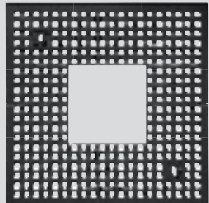

REGULUS
P. 46



OCTA
P. 52

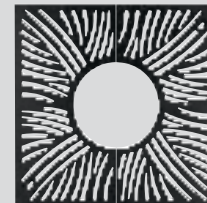

SERPO Q
P. 58

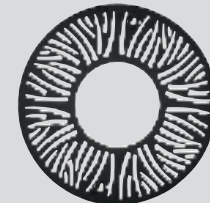

SERPO R
P. 62

TREE GUARDS

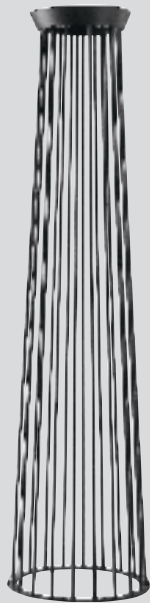

SCULPO
P. 84



METOR
P. 86

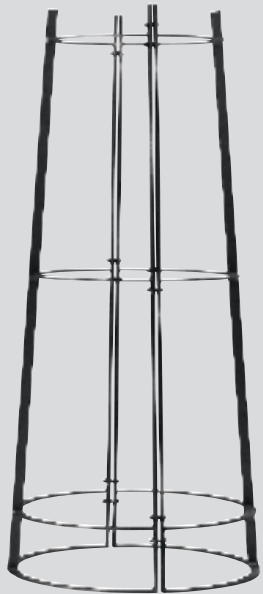

WEGA
P. 88

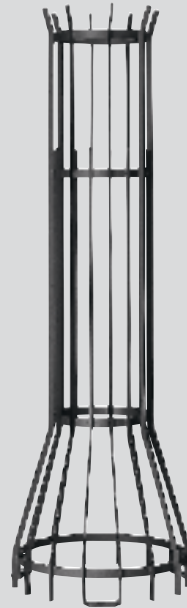

ALGARVE
P. 90

VERONA

Design: Jean-Marc Schneider

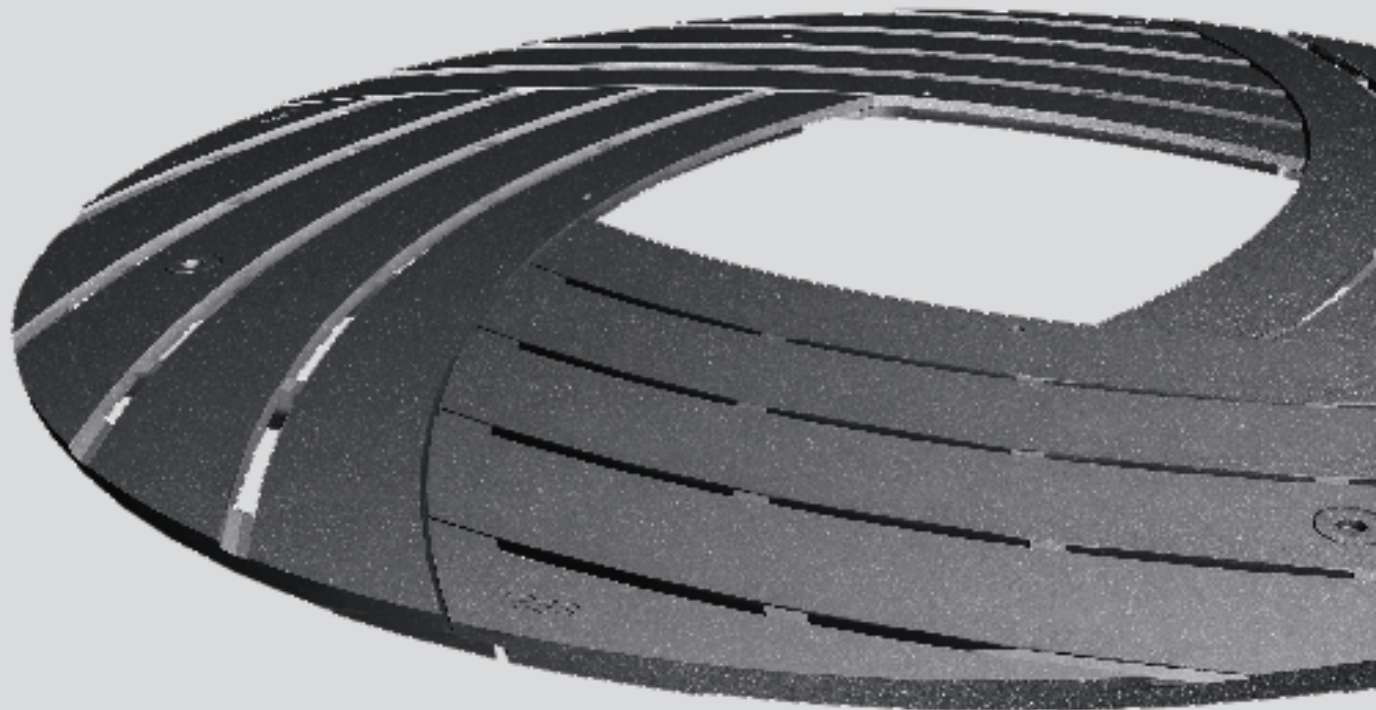

Product information
www.hess.eu/0150

QTC
HESS QTC - QUALITY TESTED AND CERTIFIED

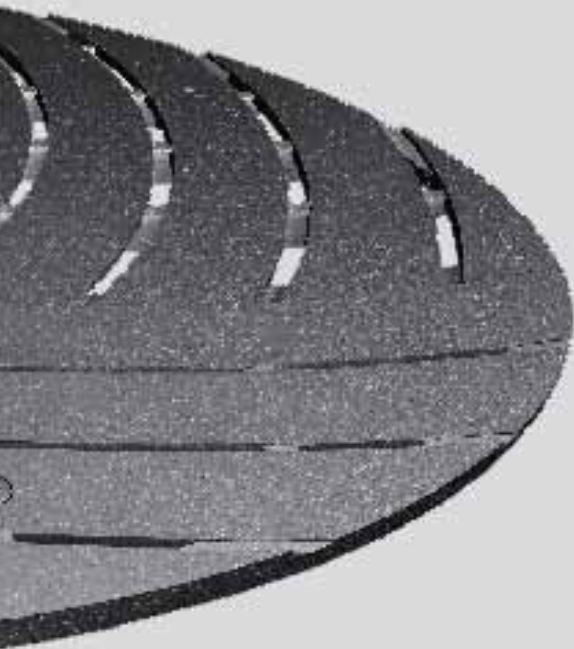

VERONA 3 T - D . Decorative Tree Grate

Hand cast, round tree grate with square inner opening for the tree. Four segments assemble loosely in a cantilever frame. Two of the segments have watering openings with covers. Powder coated black matte finish.

Additional charge: Segment fitted for PESARO B HP LED in-ground luminaire. Segments fitted for tree support posts provided by others.



VERONA 3 T - D
Hand cast

VERONA 3 T - D

Tree Grate							Wheel	Frame	Concrete Foundation	
Order No.	Nominal Dimensions	Dimensions in mm					Load	Order No.	Order No.	Order No.
		A	B	H	S	E			Height 260 mm	Height 400 mm
30.12600.0	R 1000 / R 340	980	340	70	10	30	3 t	30.41110.0	30.70010.0	30.70010.2
30.12601.0	R 1500 / R 520	1480	520	70	12	30	3 t	30.41200.0	30.70012.0	30.70012.2
30.12602.0	R 2000 / R 700	1980	700	70	19	30	3 t	30.41220.6	30.70020.6	30.70020.7

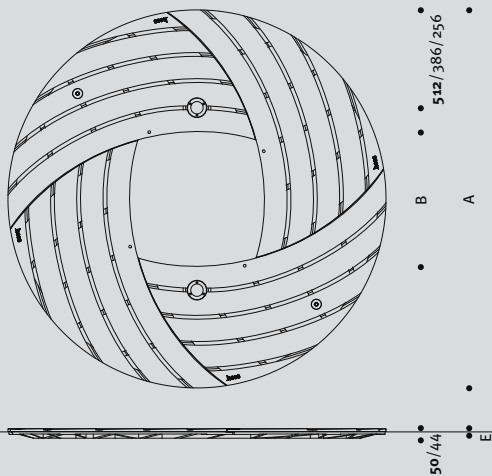
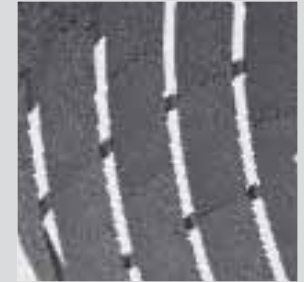

- A Outer grate measurement
- B Grate opening size
- H Height of the frame incl. tree grate
- S Width of grate slits
- E Inlay depth of the grate in the frame

VERONA

R 1000/
R 340

R 1500/
R 520

R 2000/
R 700

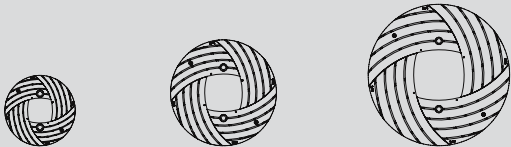

MATCHING FITTINGS FOR POSTS

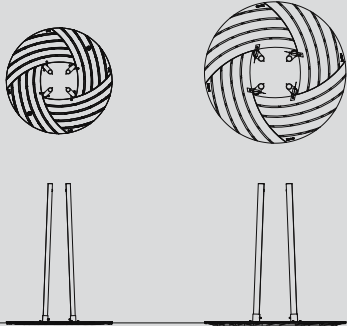

PICENO

Design: Jean-Marc Schneider

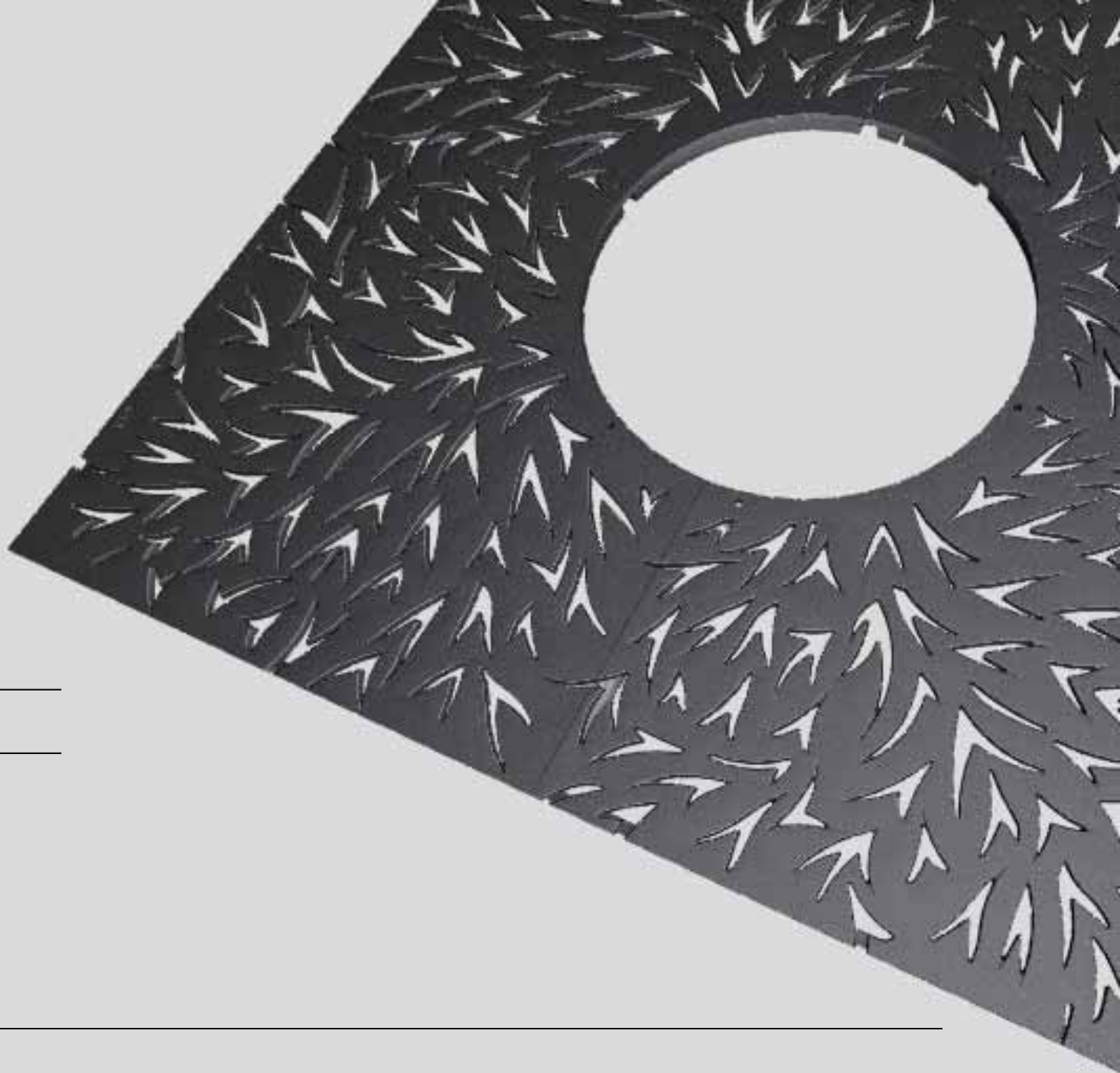

Product information
www.hess.eu/0153

QTC
HESS QTC - QUALITY TESTED AND CERTIFIED

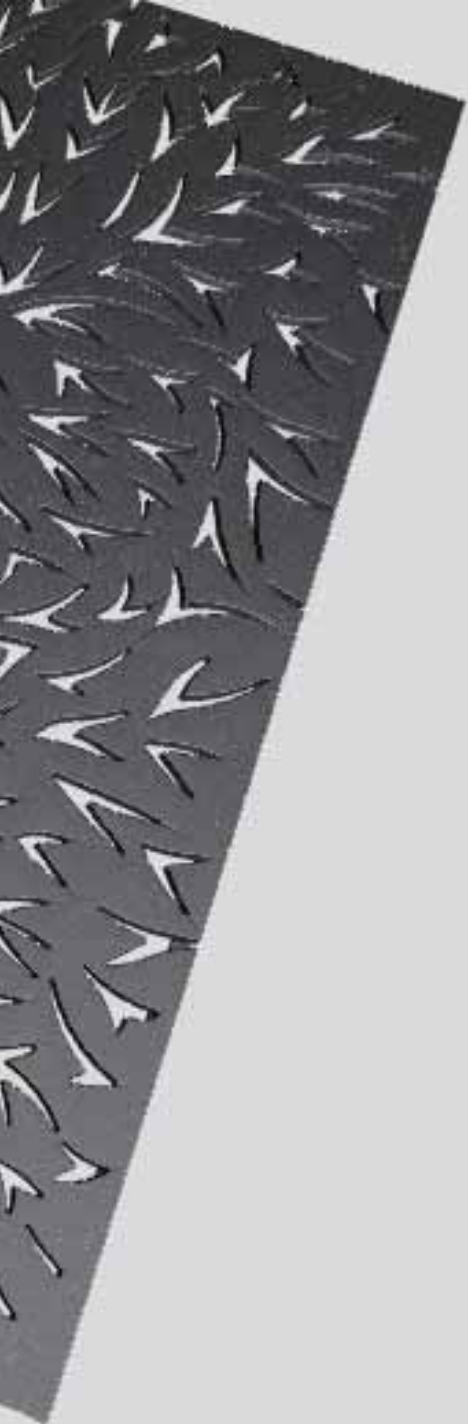

P I C E N O 3 T - D . Decorative Tree Grate

Hand cast, square tree grate with round inner opening for the tree. Two segments, each with a watering hole and cover, assemble loosely in a cantilever frame. Powder coated black matte finish.

Additional charge: Segment fitted for PESARO B HP LED in-ground luminaire.



P I C E N O 3 T - D
Hand cast

PICENO 3 T - D

Tree Grate							Wheel	Frame	Concrete Foundation	
Order No.	Nominal Dimensions	Dimensions in mm					Load	Order No.	Order No.	Order No.
		A	B	H	S	E			Height 260 mm	Height 400 mm
30.12701.0	Q 1500 / R 620	1480	620	70	-	30	3 t	30.41200.1	30.70012.1	30.70012.3
30.12702.0	Q 2000 / R 825	1980	825	70	-	30	3 t	30.41220.4	30.70020.4	30.70020.5

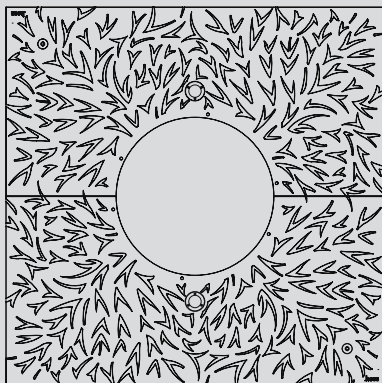

- A Outer grate measurement
- B Grate opening size
- H Height of the frame incl. tree grate
- S Width of grate slits
- E Inlay depth of the grate in the frame



50/45

PICENO

Q 1500/
R 620

Q 2000/
R 825

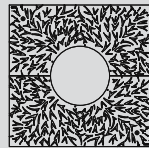

MATCHING TREE GUARDS

SCULPO
R 1

R 2

METOR
R 1

R 2

WEGA
R 1

R 2



MARINO

Design: Sven von Boetticher

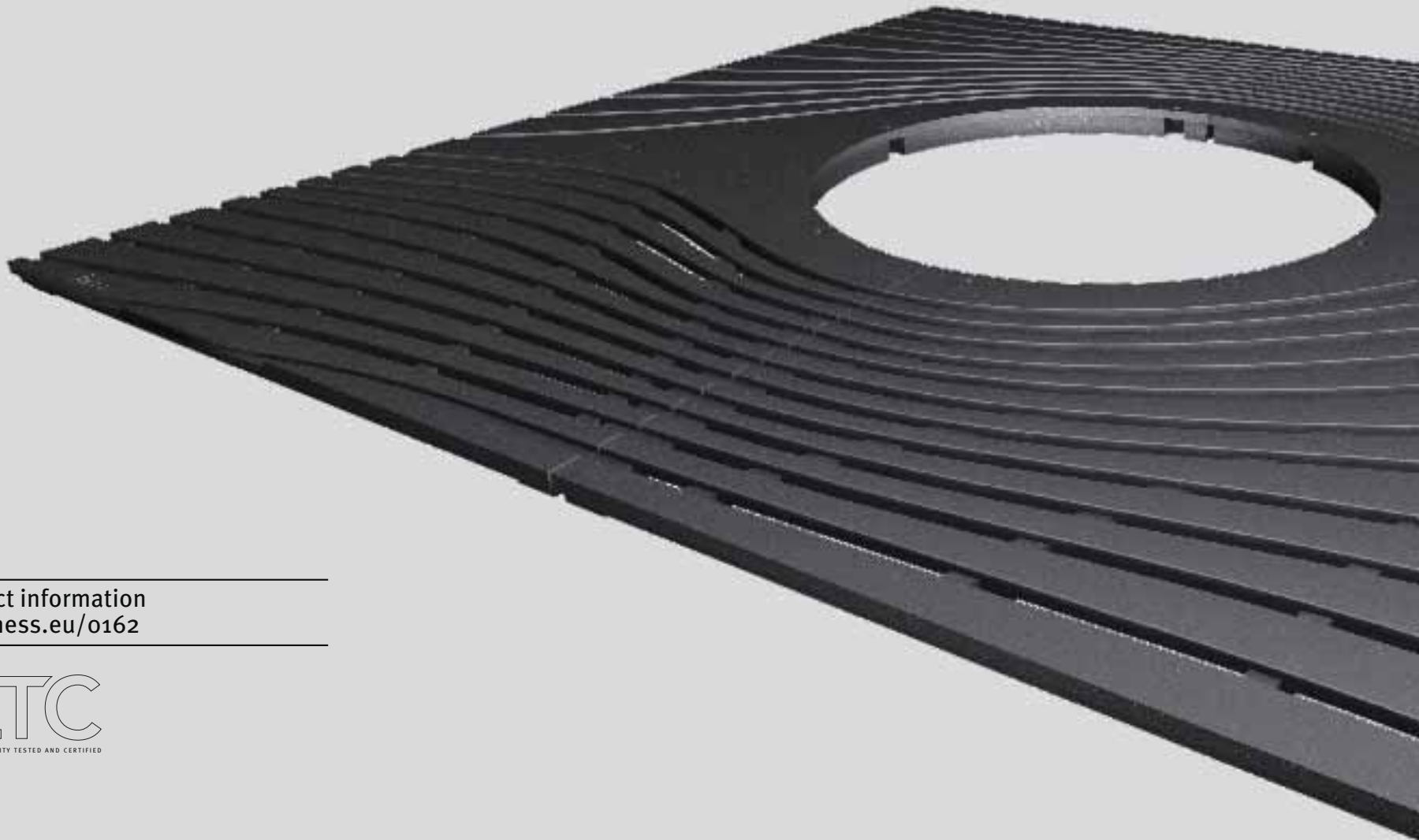

Product information
www.hess.eu/o162





MARINO 3 T - D . Decorative Tree Grate

Hand cast, square tree grate with round inner opening for the tree. Two segments, each with a watering hole and cover, assemble loosely in a cantilever frame. Powder coated black matte finish.

Additional charge: Segment fitted for PESARO B HP LED in-ground luminaire.



MARINO 3 T - D
Hand cast

MARINO 3 T - D

Tree Grate							Wheel	Frame	Concrete Foundation	
Order No.	Nominal Dimensions	Dimensions in mm					Load	Order No.	Order No.	Order No.
		A	B	H	S	E			Height 260 mm	Height 400 mm
30.12800.0	Q 1000 / R 300	980	410	70	11	30	3 t	30.41110.1	30.70010.1	30.70010.3
30.12801.0	Q 1500 / R 620	1480	620	70	13	30	3 t	30.41200.1	30.70012.1	30.70012.3
30.18202.0	Q 2000 / R 825	1980	825	70	19	30	3 t	30.41220.4	30.70020.4	30.70020.5



• 835/619/410 •

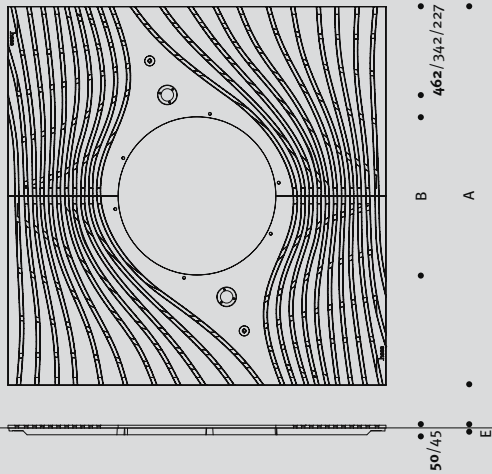

- A Outer grate measurement
- B Grate opening size
- H Height of the frame incl. tree grate
- S Width of grate slits
- E Inlay depth of the grate in the frame

MARINO

Q 1000/
R 300

Q 1500/
R 620

Q 2000/
R 825

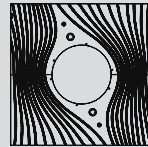
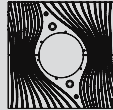

MATCHING TREE GUARDS

SCULPO
R 1

R 2

METOR
R 1

R 2

WEGA
R 1

R 2







PADOVA

Design: Sven von Boetticher

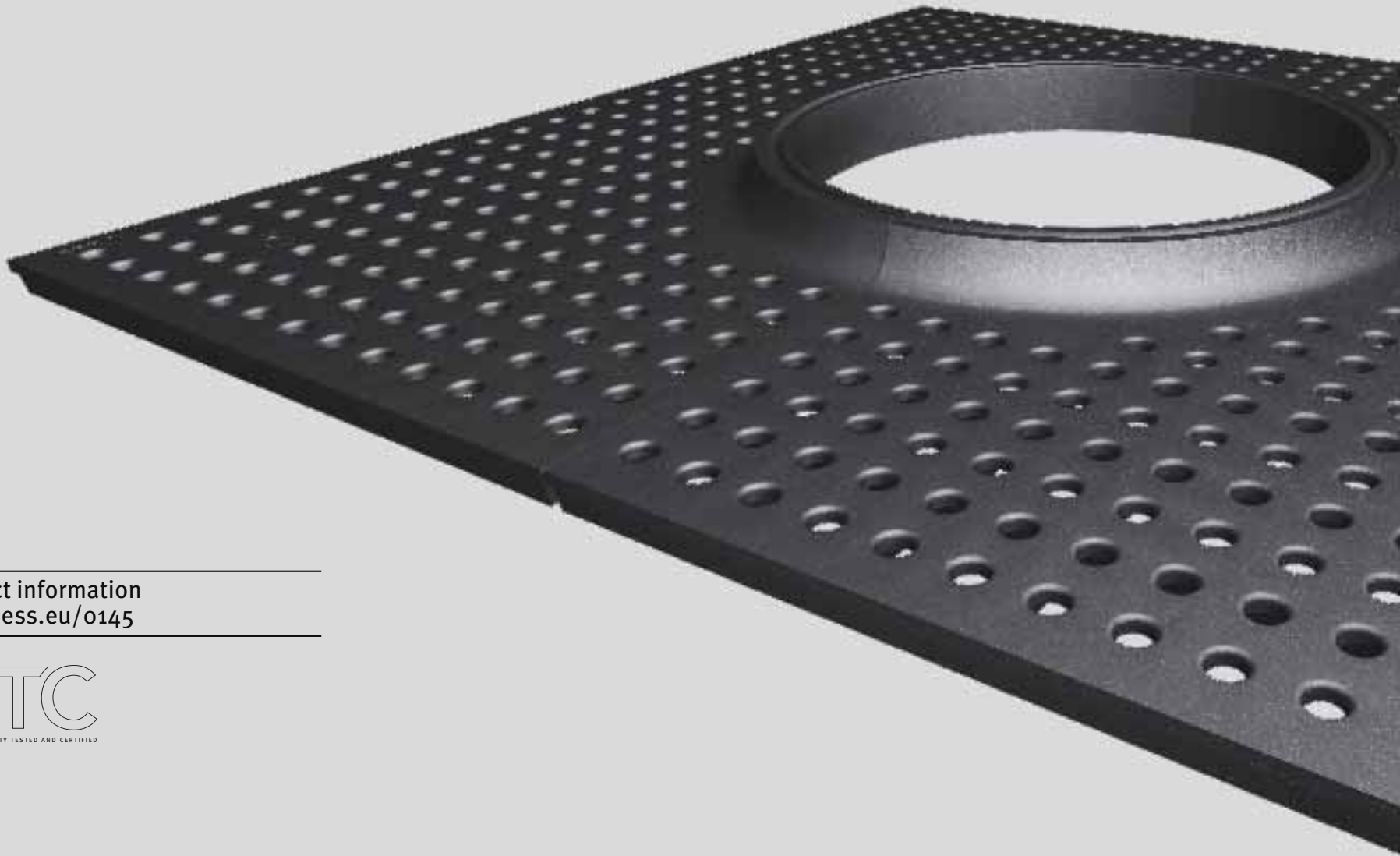

Product information
www.hess.eu/0145

QTC
HESS QTC - QUALITY TESTED AND CERTIFIED



PADOVA 3 T - D . Decorative Tree Grate

Hand cast, square tree grate with round inner opening for the tree. Two segments, each with a watering hole and cover, assemble loosely in a cantilever frame. Powder coated black matte finish.

Additional charge: Integral light ring in inner opening for diffused effect lighting. Segment fitted for PESARO B HP LED in-ground luminaire.



PADOVA 3 T - D
Hand cast

PADOVA 3 T - D

Tree Grate								Wheel	Frame	Concrete Foundation	
Order No.	Nominal Dimensions	Dimensions in mm						Load	Order No.	Order No.	Order No.
		A	B	H	S	E	Height 260 mm			Height 400 mm	
30.12901.0	Q 1500 / R 620	1480	620	70	Ø27	30	3 t	30.41200.1	30.70012.1	30.70012.3	
30.12902.0	Q 2000 / R 825	1980	825	70	Ø37	30	3 t	30.41220.4	30.70020.4	30.70020.5	

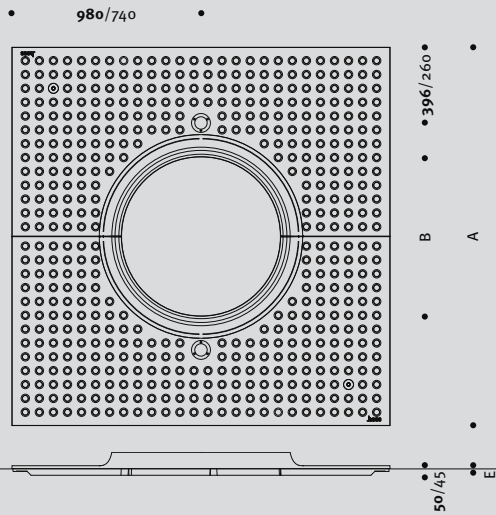

- A Outer grate measurement
- B Grate opening size
- H Height of the frame incl. tree grate
- S Width of grate slits
- E Inlay depth of the grate in the frame

PADOVA

Q 1500/
R 620

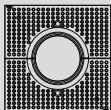

Q 2000/
R 825

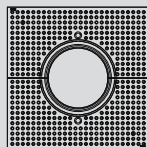

VINCENZE

Design: Sven von Boetticher

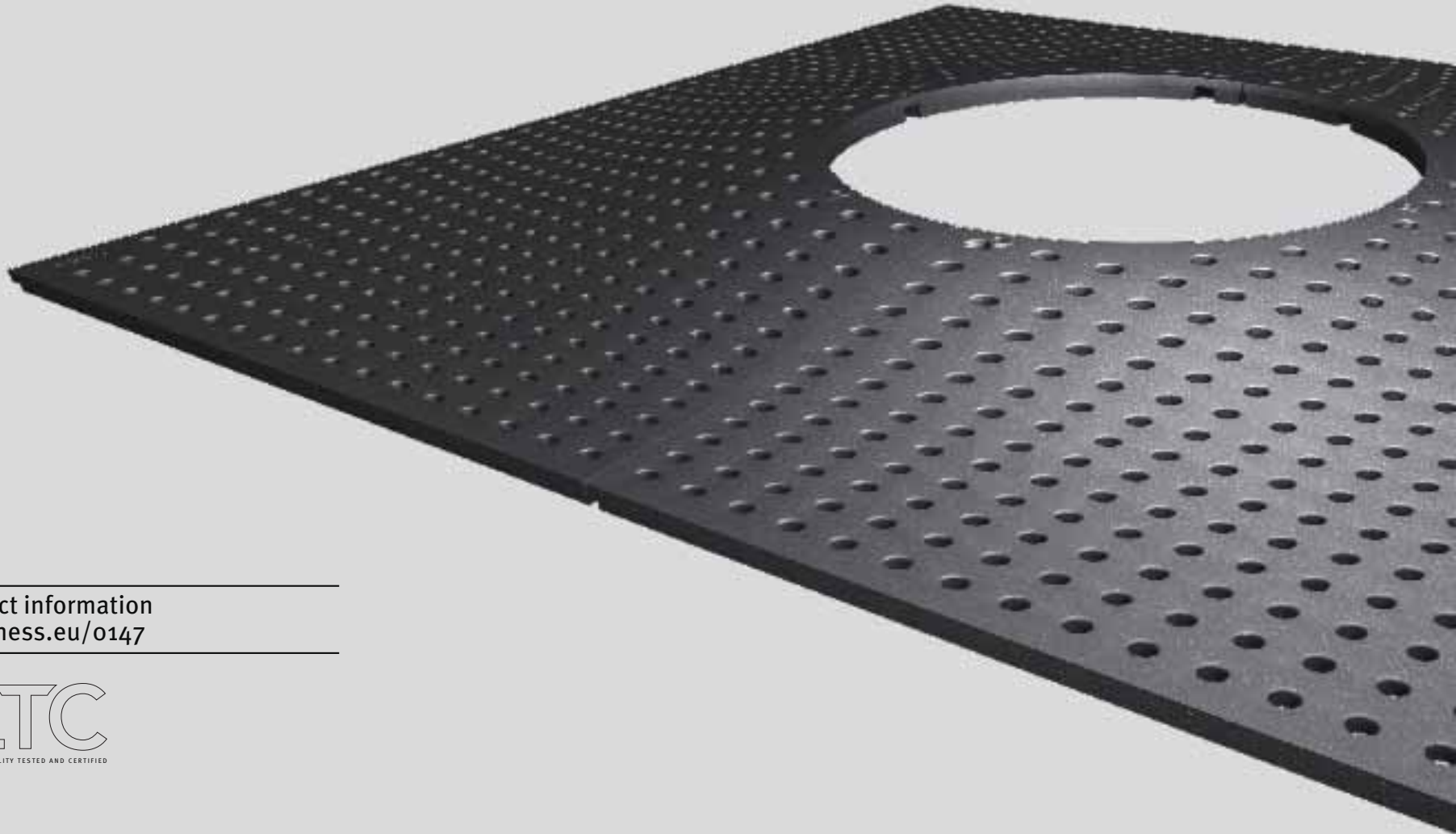

Product information
www.hess.eu/0147

QTC
HESS QTC - QUALITY TESTED AND CERTIFIED



VINCENZE 3 T - D . Decorative Tree Grate

Hand cast, square tree grate with round inner opening for the tree. Two segments, each with a watering hole and cover, assemble loosely in a cantilever frame. Powder coated black matte finish.

Additional charge: Segment fitted for PESARO B HP LED in-ground luminaire.



VINCENZE 3 T - D
Hand cast

VINCENZE 3 T - D

Tree Grate		Wheel						Frame	Concrete Foundation		
Order No.	Nominal Dimensions	Dimensions in mm						Load	Order No.	Order No.	Order No.
		A	B	H	S	E	Height 260 mm			Height 400 mm	
30.13000.0	Q 1000 / R 300	980	410	70	12/20	30	3 t	3041110.1	30.70010.1	30.70010.3	
30.13001.0	Q 1500 / R 620	1480	620	70	15/24	30	3 t	30.41200.1	30.70012.1	30.70012.3	
30.13002.0	Q 2000 / R 825	1980	825	70	21/33	30	3 t	30.41220.4	30.70020.4	30.70020.5	

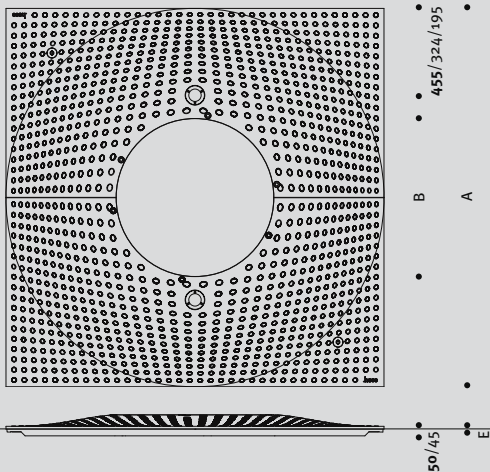

- A Outer grate measurement
- B Grate opening size
- H Height of the frame incl. tree grate
- S Width of grate slits
- E Inlay depth of the grate in the frame

VINCENZE

Q 1000/
R 300

Q 1500/
R 620

Q 2000/
R 825

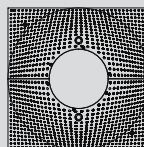
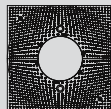

MATCHING TREE GUARDS

SCULPO
R 1

R 2

METOR
R 1

R 2

WEGA
R 1

R 2







MONZA

Design: Axe Saõne



Product information
www.hess.eu/0149

QTC
HESS QTC - QUALITY TESTED AND CERTIFIED

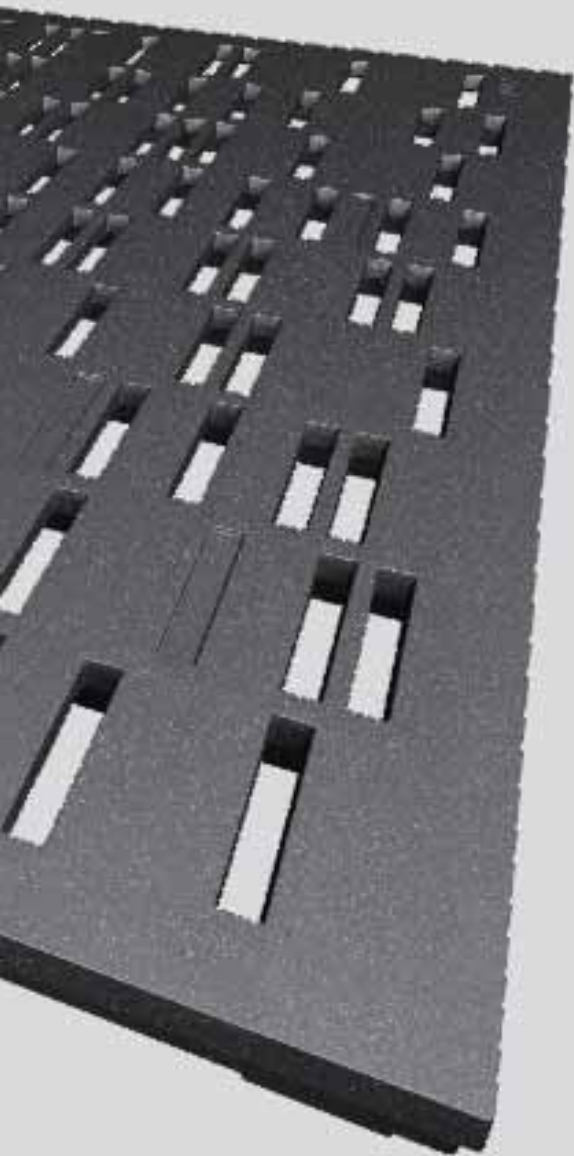

MONZA 1.5 T - D . Decorative Tree Grate

Hand cast, square tree grate with square inner opening for the tree. Two segments, each with a watering hole and cover, assemble loosely in a cantilever frame. Powder coated black matte finish.



MONZA 1.5 T - D
Hand cast

MONZA 1.5 T - D

Tree Grate							Wheel	Frame	Concrete Foundation	
Order No.	Nominal Dimensions	Dimensions in mm					Load	Order No.	Order No.	Order No.
		A	B	H	S	E			Height 260 mm	Height 400 mm
30.13101.0	Q 1580 / Q 474	1562	474	70	18	30	1.5 t	30.43101.0	30.70031.0	30.70031.2

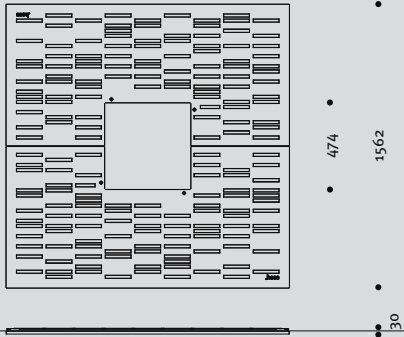

- A Outer grate measurement
- B Grate opening size
- H Height of the frame incl. tree grate
- S Width of grate slits
- E Inlay depth of the grate in the frame

MONZA

Q 1580/

Q 474

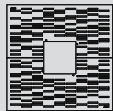

MATCHING TREE GUARDS

SCULPO

Q 1

METOR

Q 1



PICENO VARIO

Design: Jean-Marc Schneider



Product information
www.hess.eu/o180

QTC
HESQ QTC - QUALITY TESTED AND CERTIFIED

PICENO VARIO 3 T - D. Decorative Tree Grate

Hand cast modular segments configure individually for variable outer and inner forms. Segments sit loosely in a bearing frame. Comes with watering hole and cover and/or fit for PESARO B HP in-ground luminaire. Powder coated black matte finish.



PICENO VARIO 3 T - D
Hand cast



PICENO VARIO

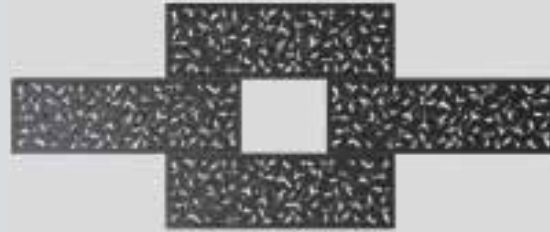

A SYSTEMATIC TREE GRATE

PICENO VARIO is a new system with unmatched flexibility. With it, landscape architects are free to improvise without infringing on the needs of older trees. PICENO VARIO opens up a completely new dimension in the use of tree grates.

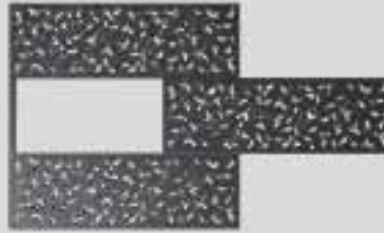
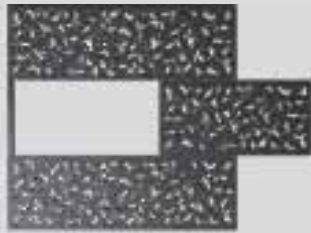

PICENO VARIO 3 T - D

Tree Grate

Order No.	Nominal Dimensions	Dimensions in mm					Wheel	Watering Cover	Luminaire	Frame
		A	B	H	S	E	Load			
30.13200.0	1200 x 600	1180	580	110	-	30	3 t	-	-	30.43200.0
30.13201.0	1200 x 600	1180	580	110	-	30	3 t	•	•	30.43200.0
30.13202.0	1200 x 600	1180	580	110	-	30	3 t	•	-	30.43200.0
30.13200.1	1800 x 600	1780	580	110	-	30	3 t	-	-	30.43200.1
30.13201.1	1800 x 600	1780	580	110	-	30	3 t	-	•	30.43200.1
30.13202.1	1800 x 600	1780	580	110	-	30	3 t	•	-	30.43200.1
30.13203.1	1800 x 600	1780	580	110	-	30	3 t	•	•	30.43200.1



U Element

30.43200.2

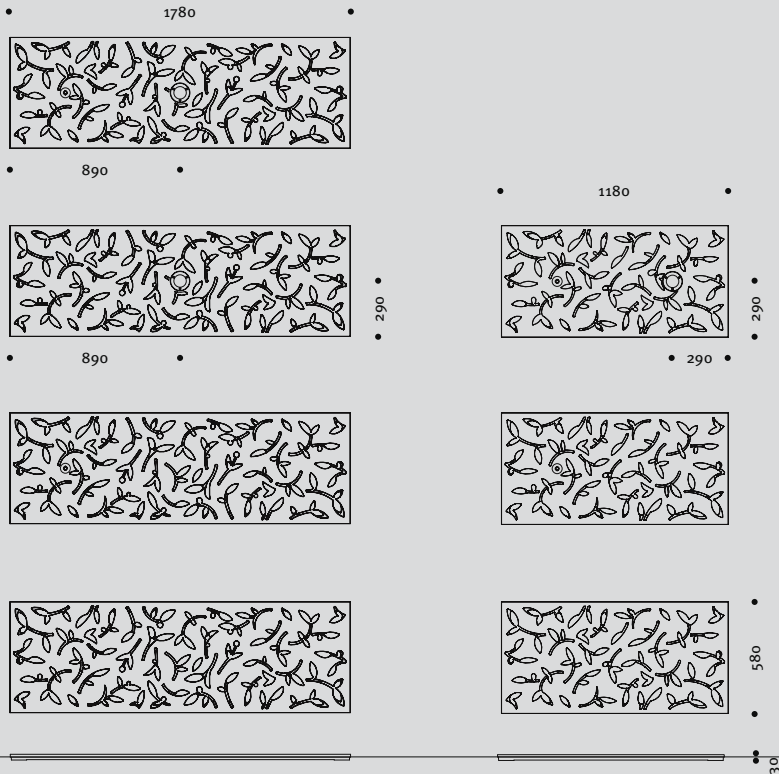

- A Outer grate measurement
- B Grate opening size
- H Height of the frame incl. tree grate
- S Width of grate slits
- E Inlay depth of the grate in the frame

PICENO VARIO

1200 x 600

1800 x 600

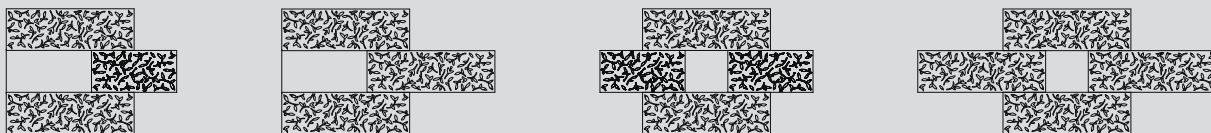
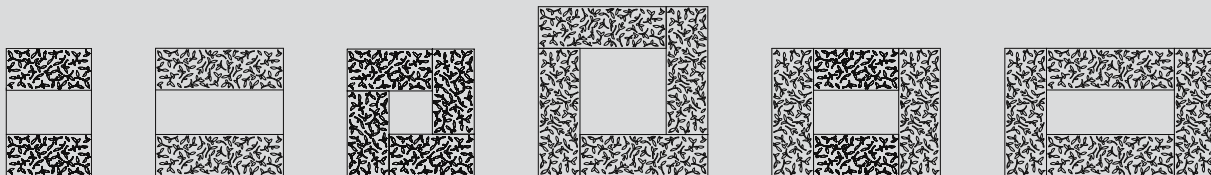

REGULUS

Design: Jean-Michel Wilmotte

Product information
www.hess.eu/0104

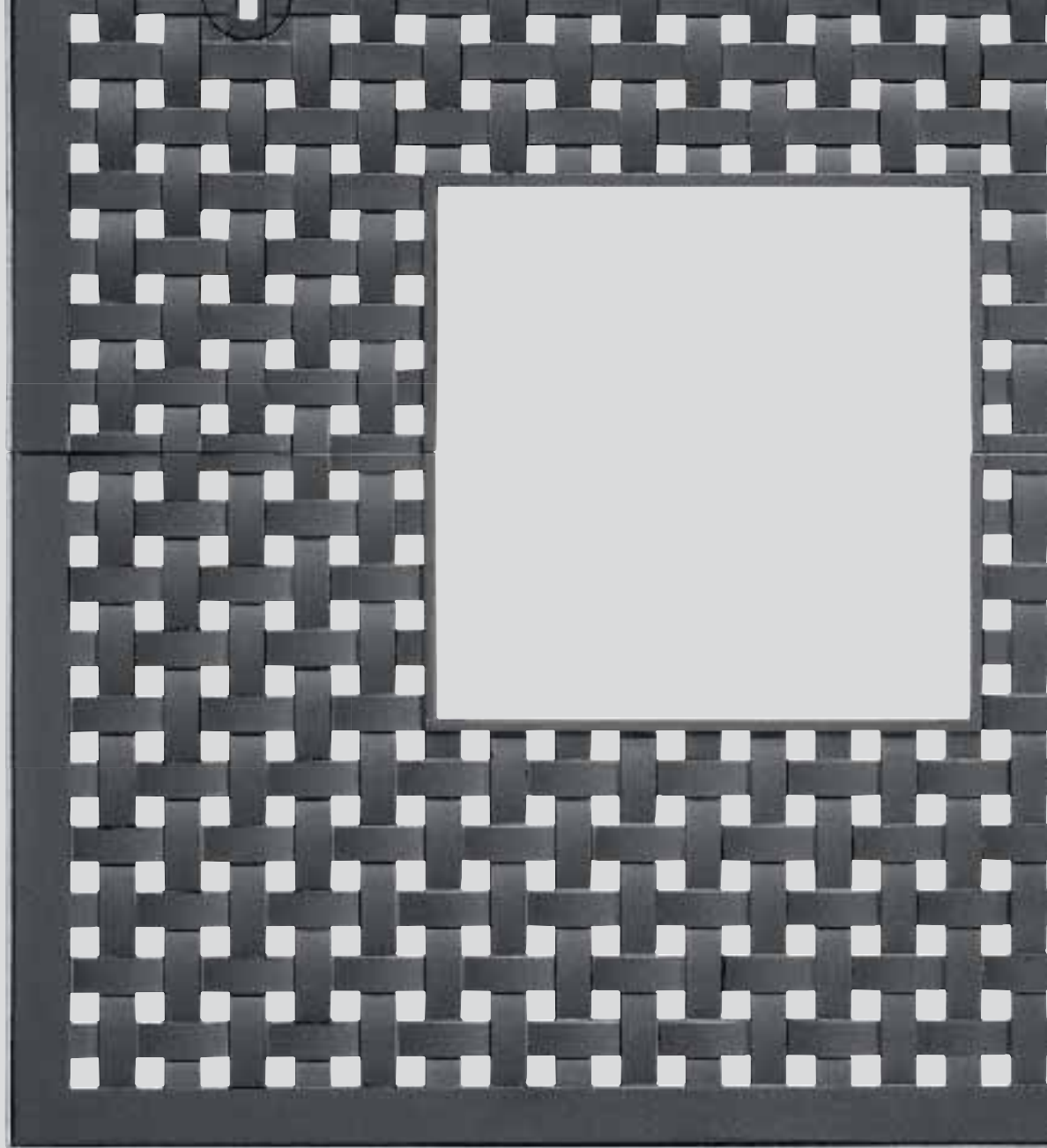

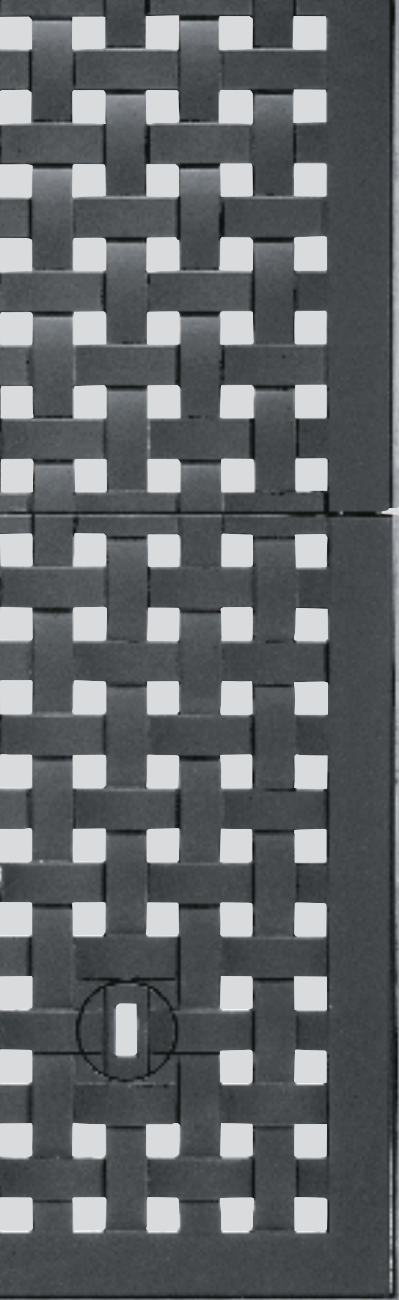

REGULUS 5 T - D . Decorative Tree Grate

Hand cast tree grate. Two-segment construction with one watering opening and cover installs loosely in cantilever frame. Forms square outer form and square inner opening for the tree. Powder coated black matte finish.

Additional charge: Segment fitted for PALERMO G 240 in-ground luminaire.

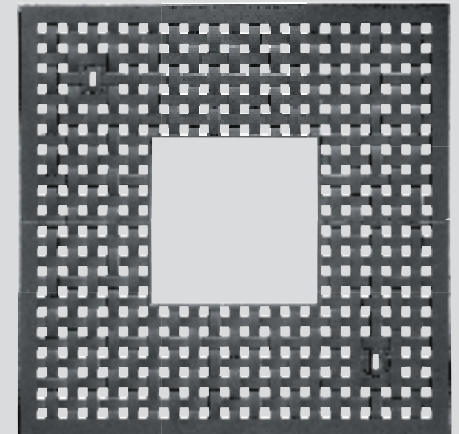

REGULUS 5 T - D
Hand cast

REGULUS 5 T - D

Tree Grate							Frame	Concrete Foundation	
Order No.	Nominal Dimensions	Dimensions in mm					Order No.	Order No.	Order No.
		A	B	H	S	E		Height 260 mm	Height 400 mm
30.12200.1	Q 1500 / Q 570	1480	570	70	30	30	30.41200.1	30.70012.1	30.70012.3
30.12201.1	Q 1800 / Q 570	1800	570	70	30	30	30.41201.1	30.70013.1	30.70013.3
30.12202.1	Q 2000 / Q 840	1944	840	70	30	30	30.41202.1	30.70014.1	30.70014.3

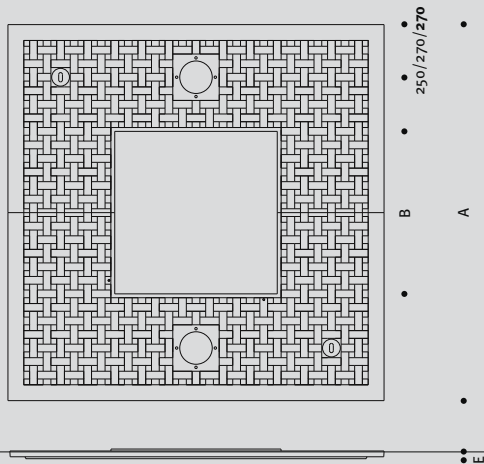
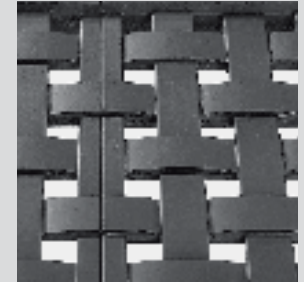

- A Outer grate measurement
- B Grate opening size
- H Height of the frame incl. tree grate
- S Width of grate slits
- E Inlay depth of the grate in the frame

TREE GRATES - D

Q 1500/
Q 570

Q 1800/
Q 570

Q 2000/
Q 840

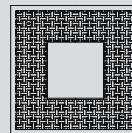
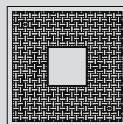
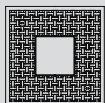

MATCHING TREE GUARDS

SCULPO
Q 1

Q 2

METOR
Q 1

Q 2

ALGARVE
Q 1

Q 2

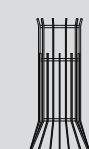



REGULUS
HEIDENHEIM . GERMANY

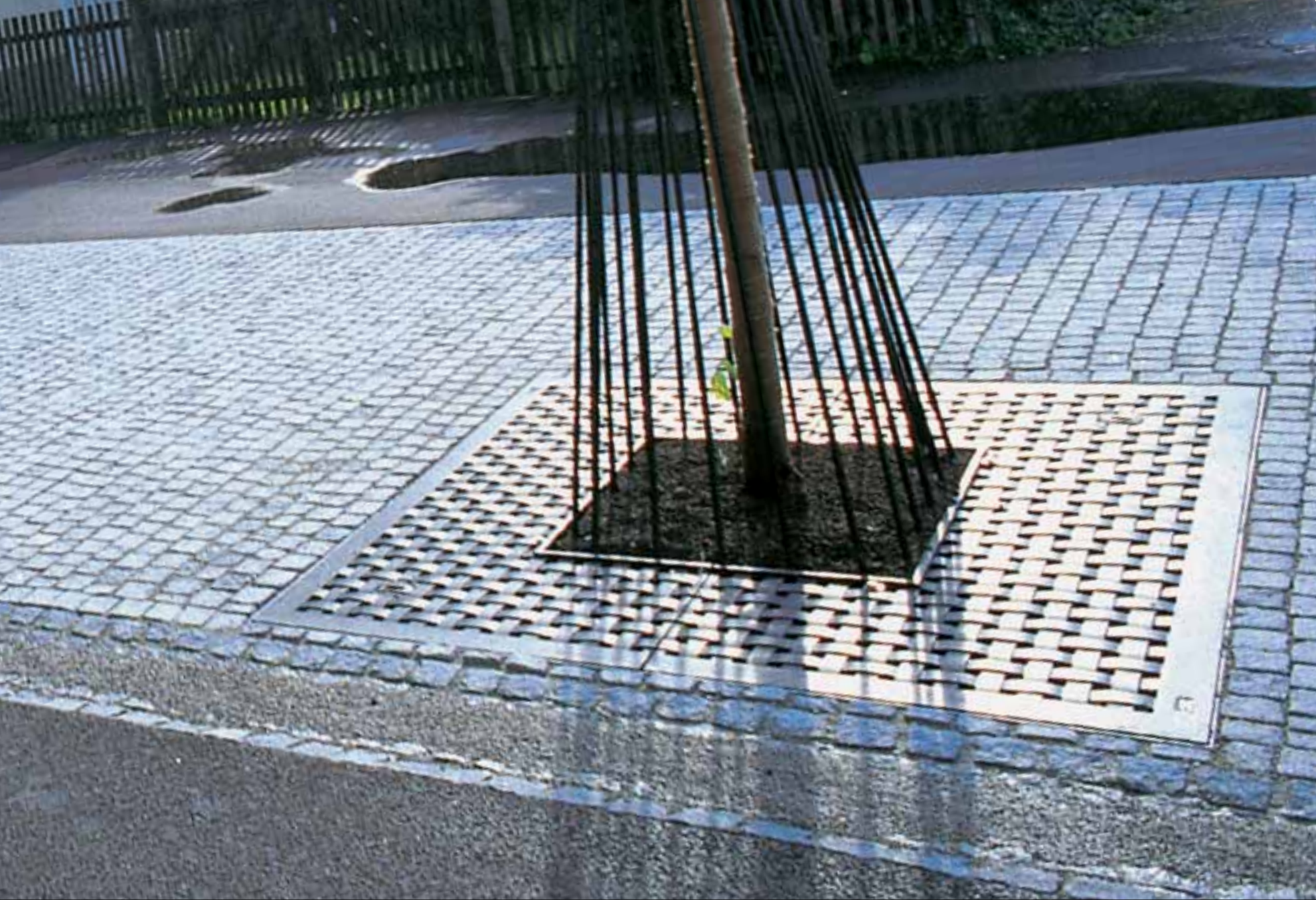

OCTA

Design: Jean-Marc Schneider

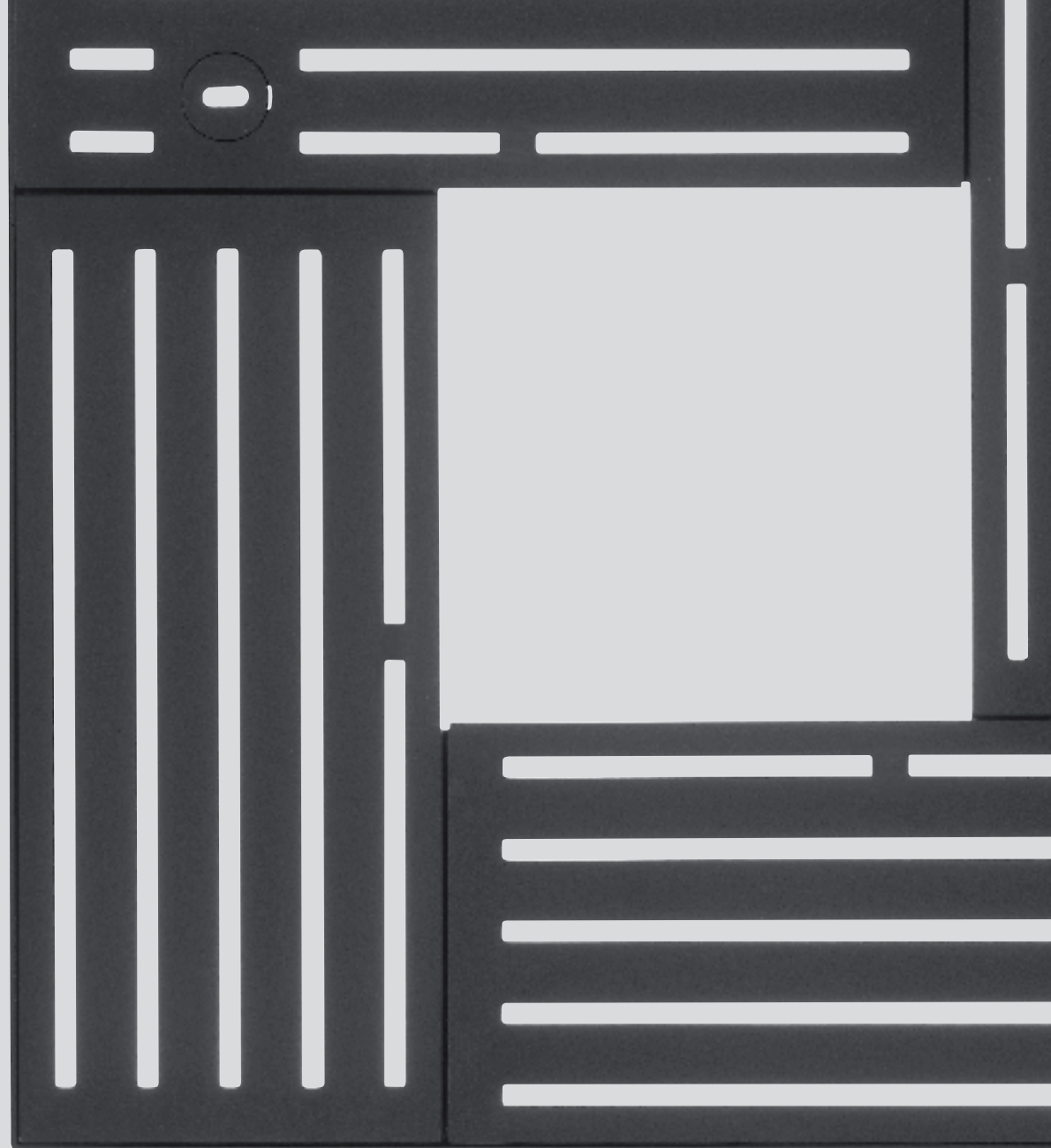

Product information
www.hess.eu/o188

QTC
HESQ QTC - QUALITY TESTED AND CERTIFIED

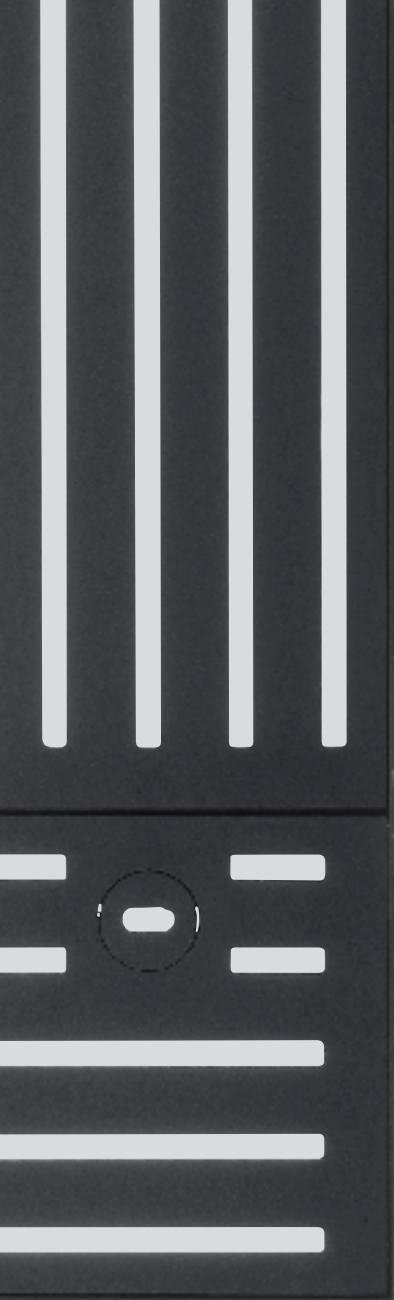

OCTA 5 T - D . Decorative Tree Grate

Hand cast tree grate manufactured from solid cast iron. Four segments assemble loosely in a cantilever frame forming a square outer shape with square inner opening for the tree. Watering hole and cover included. Powder coated black matte finish.

Additional charge: Segment fitted for RAVENNA G 220 in-ground luminaire.

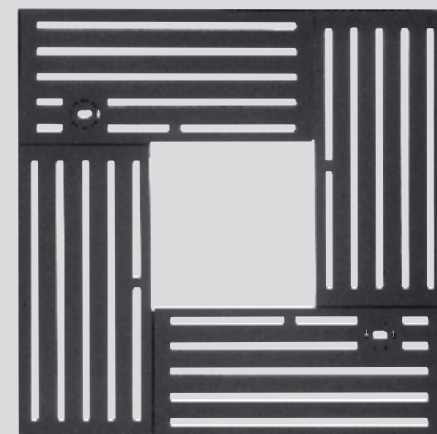

OCTA 5 T - D
Hand cast

OCTA 5 T - D

Tree Grate							Frame	Concrete Foundation		
Order No.	Nominal Dimensions	Dimensions in mm					Order No.	Order No.	Order No.	
		A	B	H	S	E		Height 260 mm	Height 400 mm	
30.12300.1	Q 1500 / Q 570	1480	570	70	20	30	30.41200.1	30.70012.1	30.70012.3	
30.12301.1	Q 1800 / Q 570	1800	570	70	20	30	30.41201.1	30.70013.1	30.70013.3	
30.12302.1	Q 2000 / Q 840	1944	840	70	20	30	30.41202.1	30.70014.1	30.70014.3	

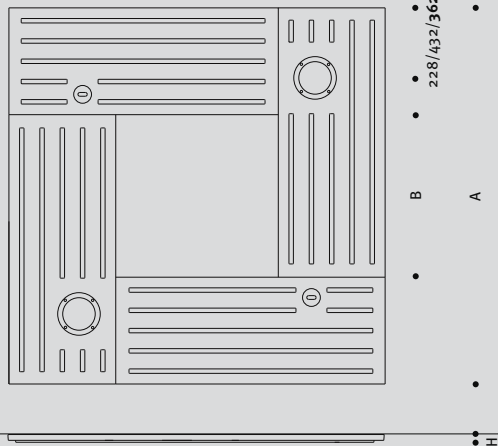
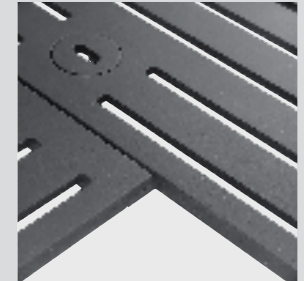
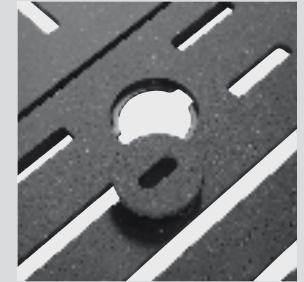

- A Outer grate measurement
- B Grate opening size
- H Height of the frame incl. tree grate
- S Width of grate slits
- E Inlay depth of the grate in the frame

TREE GRATES - D

Q 1500/
Q 570

Q 1800/
Q 570

Q 2000/
Q 840

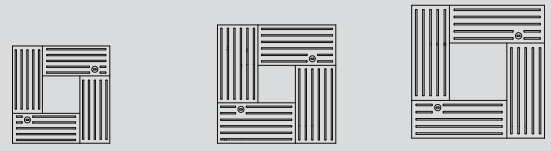

MATCHING TREE GUARDS

SCULPO
Q 1

Q 2

METOR
Q 1

Q 2

ALGARVE
Q 1

Q 2

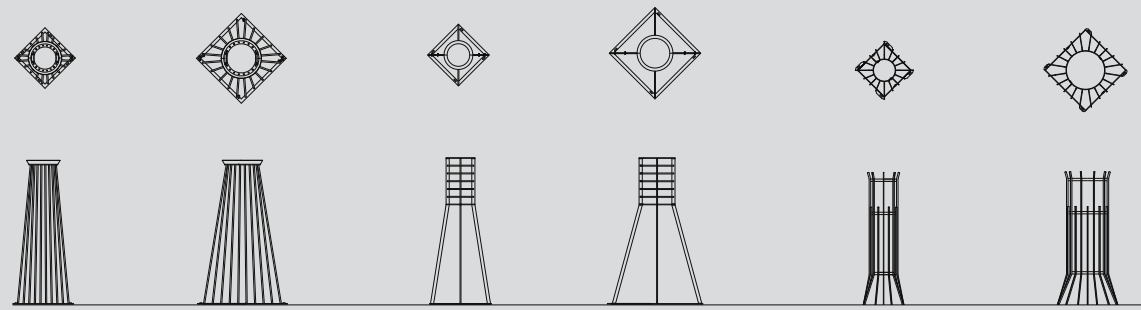



REGULUS
MUNICH . GERMANY



SERPO Q

Design: Jean-Marc Schneider

Product information
www.hess.eu/o160

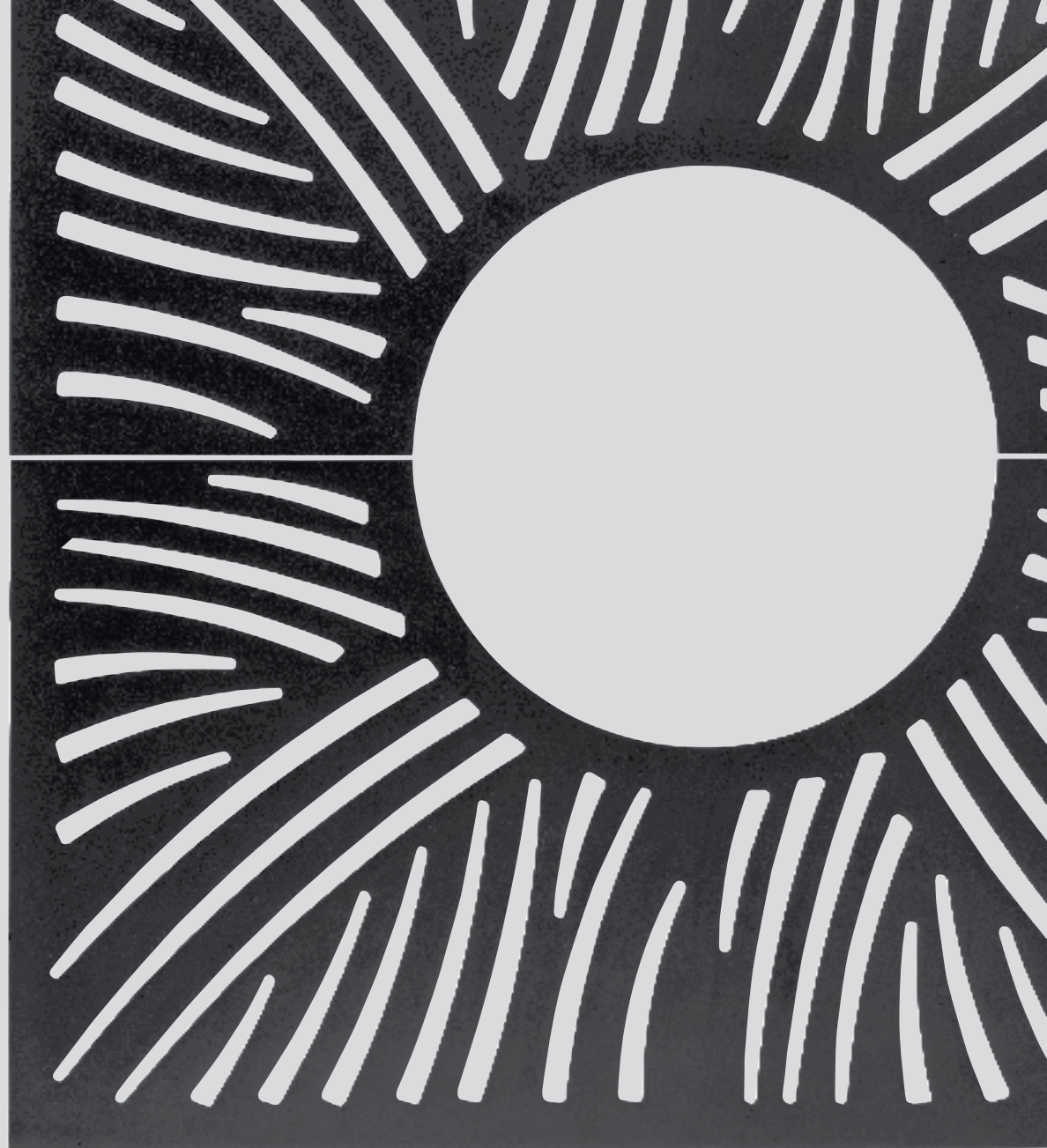



SERPO Q 5 T - D . Decorative Tree Grate

Hand cast, square tree grate with round inner opening for the tree sits loosely in cantilever frame. Powder coated black matte finish.

Additional charge: Segment fitted for RAVENNA G 220 in-ground luminaire.

SERPO Q 5 T - D
Hand cast

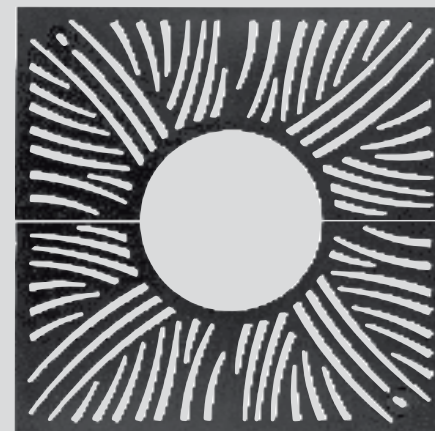

SERPO Q 5 T - D

Tree Grate							Frame	Concrete Foundation	
Order No.	Nominal Dimensions	Dimensions in mm					Order No.	Order No.	Order No.
		A	B	H	S	E		Height 260 mm	Height 400 mm
30.12400.1	Q 1500 / R 620	1480	620	70	-	30	30.41200.1	30.70012.1	30.70012.3
30.12401.1	Q 1800 / R 620	1800	620	70	-	30	30.41201.1	30.70013.1	30.70013.3
30.12402.1	Q 2000 / R 825	1944	825	70	-	30	30.41202.1	30.70014.1	30.70014.3

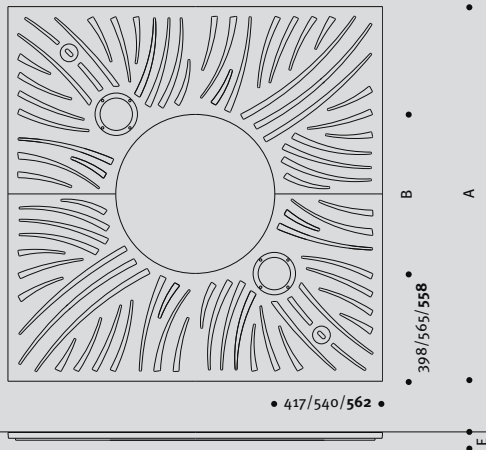
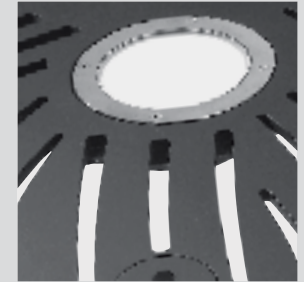

- A Outer grate measurement
- B Grate opening size
- H Height of the frame incl. tree grate
- S Width of grate slits
- E Inlay depth of the grate in the frame

TREE GRATES - D

Q 1500/
R 620

Q 1800/
R 620

Q 2000/
R 825

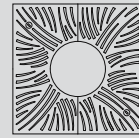
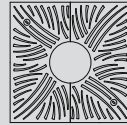

MATCHING TREE GUARDS

SCULPO
R 1

R 2

METOR
R 1

R 2

WEGA
R 1

R 2

ALGARVE
R 1

R 2

RK 1

RK 2



SERPO R

Design: Jean-Marc Schneider

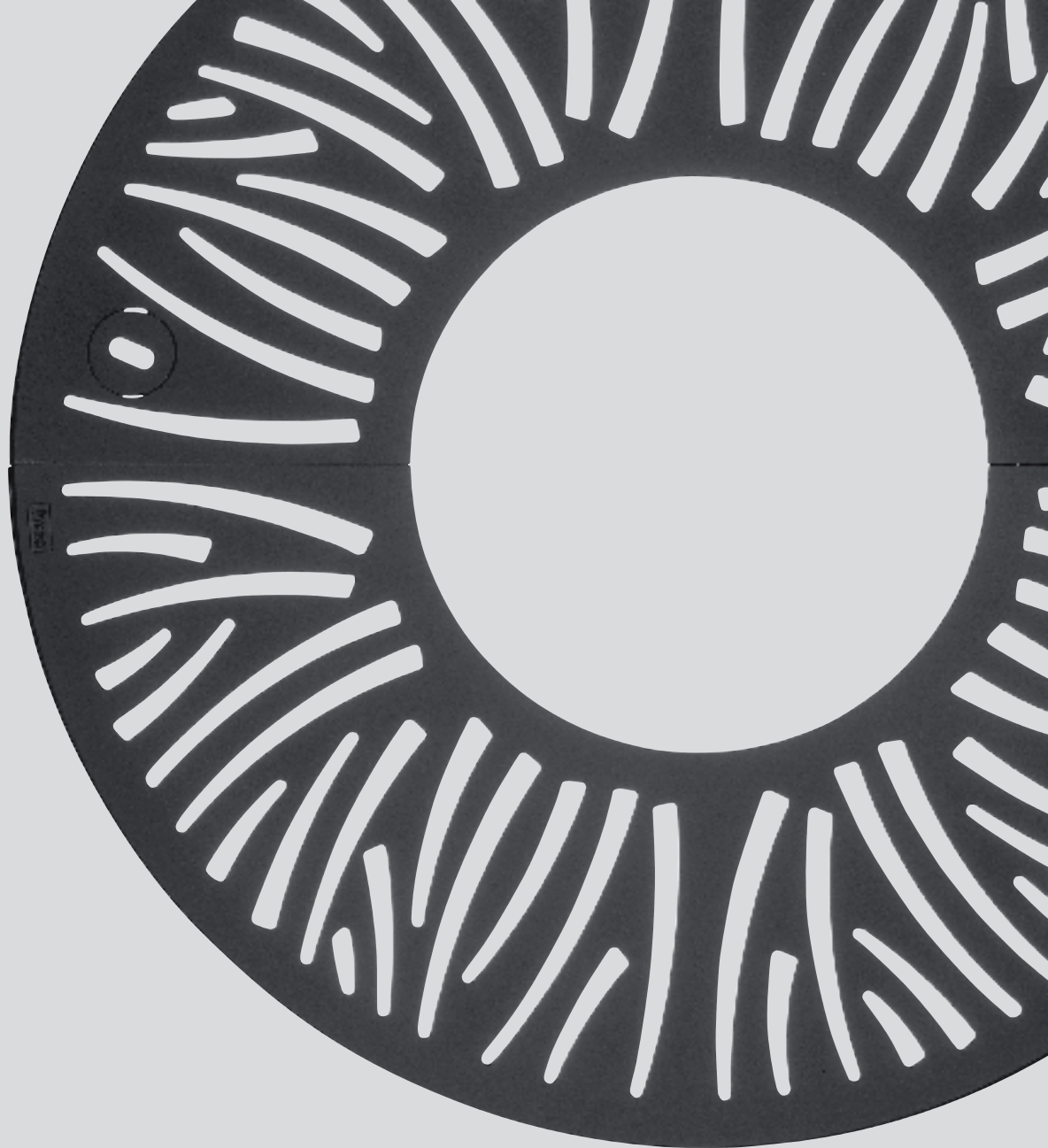

Product information
www.hess.eu/0165

QTC
HESS QTC - QUALITY TESTED AND CERTIFIED



SERPO R 5 T - D. Decorative Tree Grate

Hand cast tree grate. Two segments assemble loosely in a cantilever frame forming a round outer shape with round inner opening for the tree. One of the segments features watering opening and cover. Powder coated black matte finish.

Additional charge: Segment fitted for RAVENNA G 220 in-ground luminaire.

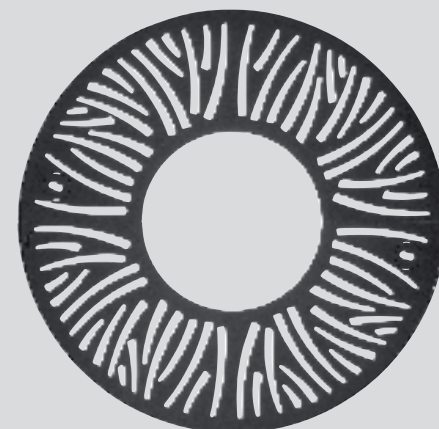

SERPO R 5 T - D
Hand cast

SERPO R 5 T - D

Tree Grate		Frame					Concrete Foundation		
Order No.	Nominal Dimensions	Dimensions in mm					Order No.	Order No.	Order No.
		A	B	H	S	E		Height 260 mm	Height 400 mm
30.12400.0	R 1500 / R 620	1480	620	70	-	30	30.41200.0	30.70012.0	30.70012.2
30.12401.0	R 1800 / R 620	1800	620	70	-	30	30.41201.0	30.70013.0	30.70013.2
30.12402.0	R 2000 / R 825	1944	825	70	-	30	30.41202.0	30.70014.0	30.70014.2

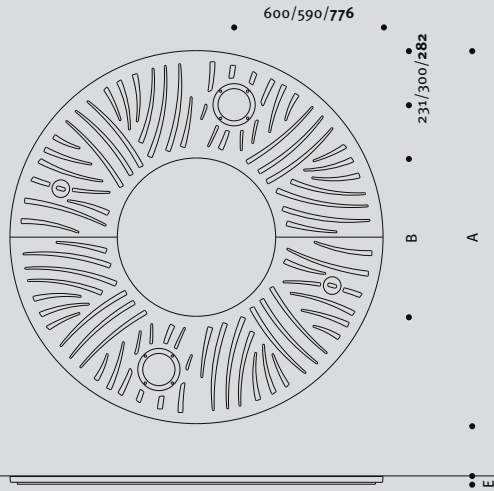

- A Outer grate measurement
- B Grate opening size
- H Height of the frame incl. tree grate
- S Width of grate slits
- E Inlay depth of the grate in the frame

TREE GRATES - D

R 1500/
R 620

R 1800/
R 620

R 2000/
R 825

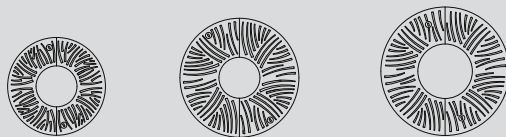

MATCHING TREE GUARDS

SCULPO
R 1

R 2

METOR
R 1

R 2

WEGA
R 1

R 2

ALGARVE
R 1

R 2

RK 1

RK 2

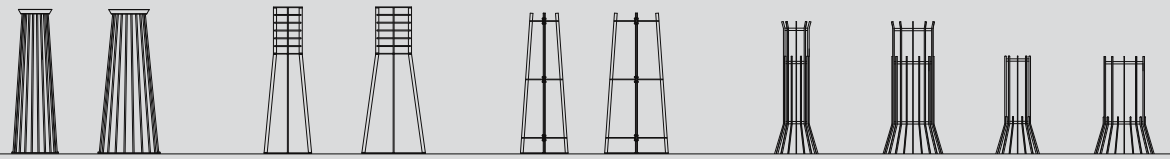



SERPO Q
LAHR . GERMANY



RAVENNA G 220 . In-ground Luminaire

Single-pane, tempered safety glass enclosure with translucent coated margin. Enclosure bonded to machined stainless steel top plate. Cast aluminium luminaire housing (Anticorodal) treated with special anti-corrosive coat. Newly developed thick powder coat with superior corrosion protection.

◆♦♦ Ingress protection IP 67 · ⊕ Protection rating I · ⚡ 10/△ · CE

Additional charge: Concentric-ringed, anti-slip surface.

Light colours (EL):

- Red
- Green
- Blue
- Amber
- White (6500 K)
- Warm white (3000 K)



RAVENNA G 220/B (symmetric/asymmetric)

Reflector	Concentric Louvres	Vertical Adjustment	Horizontal Adjustment	Order No. 45	Order No. D	Lamp												
						HIT-CE			HIE		HSE-E		TC-D		OR-LP 111		LED-HP	LED-EL
						20W	35W	70W	35W	70W	50W	70W	18W	26W	35W	50W	15W	5W
16°/35°/55°	–	•	•	12.43802.1	12.33802.1	•	•	•	–	–	–	–	–	–	–	–	–	–
16°/35°/55°	•	–	–	12.43802.1	12.33802.1	•	•	•	–	–	–	–	–	–	–	–	–	–
16°/35°/55°	–	–	–	12.43802.1	12.33802.1	•	•	•	–	–	–	–	–	–	–	–	–	–
16°/35°/55°	•	•	•	12.43802.1	12.33802.1	•	•	•	–	–	–	–	–	–	–	–	–	–
8°/24°	–	•	•	12.43802.1	12.33802.1	–	–	–	–	–	–	–	–	–	•	•	–	–
Symmetric	–	–	–	12.43802.1	12.33802.1	–	–	–	•	•	•	•	•	•	–	–	•	•
Asymmetric	–	–	–	12.43802.3	12.33802.3	–	–	–	•	•	•	•	•	•	–	–	–	–



PALERMO G 240 . In-ground Luminaire

Single-pane, tempered safety glass enclosure with translucent coated margin. Enclosure bonded to machined stainless steel top plate. Cast aluminium luminaire housing (Anticorodal) treated with special anti-corrosive coat. Newly developed thick powder coat with superior corrosion protection.

◆♦♦ Ingress protection IP 67 · ⊕ Protection rating I · ⚡ 10/△ · CE

Additional charge: Concentric-ringed, anti-slip surface.

Light colours (EL):

- Red
- Green
- Blue
- Amber
- White (6500 K)
- Warm white (3000 K)



PALERMO G 220/B (symmetric/asymmetric)

Reflector	Concentric Louvres	Vertical Adjustment	Horizontal Adjustment	Order No. 4s	Order No. D	Lamp												
						HIT-CE			HIE		HSE-E		TC-D		OR-LP 111		LED-HP	LED-EL
						20W	35W	70W	35W	70W	50W	70W	18W	26W	35W	50W	15W	5W
16°/35°/55°	–	•	•	12.43902.1	12.33902.1	•	•	•	–	–	–	–	–	–	–	–	–	–
16°/35°/55°	•	–	–	12.43902.1	12.33902.1	•	•	•	–	–	–	–	–	–	–	–	–	–
16°/35°/55°	–	–	–	12.43902.1	12.33902.1	•	•	•	–	–	–	–	–	–	–	–	–	–
16°/35°/55°	•	•	•	12.43902.1	12.33902.1	•	•	•	–	–	–	–	–	–	–	–	–	–
8°/24°	–	•	•	12.43902.1	12.33902.1	–	–	–	–	–	–	–	–	–	•	•	–	–
Symmetric	–	–	–	12.43902.1	12.33902.1	–	–	–	•	•	•	•	•	•	–	–	•	•
Asymmetric	–	–	–	12.43902.3	12.33902.3	–	–	–	•	•	•	•	•	•	–	–	–	–



PESARO B HP. In-ground Luminaire

Stainless steel luminaire housing. Heat tempered opal flashed glass enclosure installs flush with grade. 1-tonne rollover capacity. 2 m bared connecting lead with open litz wire ends. Light colours: cool white (5400 K) warm white (3300 K).

◆◆ Ingress protection: IP 67 • ⊕ Protection rating: III • **CE**

Light colours (HP):

- Cool white (5400 K)
- Warm white (3300 K)

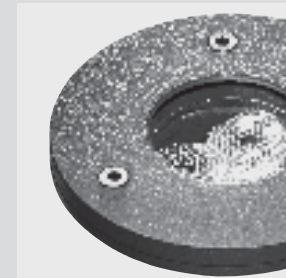

Product Name	Article No.	One-Half-Peak Divergence	Dimensions				Weight	Operating Voltage	Max. Qty./Power Units		
			A	B	C	D			100 W	200 W	300 W
			∅ mm	∅ mm	mm	mm	kg				
PESARO B HP 1 t	18.10152.0V001	10° clear	99	64.5	64.5	10	approx. .4	23-25 V DC 10 W	8	17	27
	18.10152.0V002	10° clear	99	64.5	64.5	10	approx. .4	23-25 V DC 10 W	8	17	27
	1810152.1V001	25° clear	99	64.5	64.5	10	approx. .4	23-25 V DC 10 W	8	17	27
	1810152.1V002	25° clear	99	64.5	64.5	10	approx. .4	23-25 V DC 10 W	8	17	27
	1810152.2V001	40° clear	99	64.5	64.5	10	approx. .4	23-25 V DC 10 W	8	17	27
	1810152.2V002	40° clear	99	64.5	64.5	10	approx. .4	23-25 V DC 10 W	8	17	27
	1810152.3V001	40° translucent	99	64.5	64.5	10	approx. .4	23-25 V DC 10 W	8	17	27
	1810152.3V002	40° translucent	99	64.5	64.5	10	approx. .4	23-25 V DC 10 W	8	17	27

Order No.: Article No. + LED Configuration

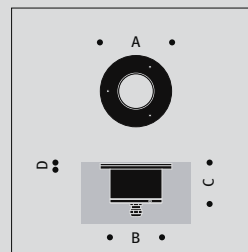

TECHNICAL INFORMATION

INSTALLATION OF IN-GROUND LUMINAIRES

Hess in-ground luminaires are designed for 5 t or 1 t rollover loads, depending on the model. “Rollover” means that tree grates can be driven over only if unavoidable and then subject to the specified wheel load limit. Turning, braking, acceleration and speeds exceeding 20 km/h must be avoided.

Electrical installation requires a cable junction box. The in-ground luminaires come equipped with a 2 m connecting cable for connection to a distribution box, e.g. cable junction box (supplied by others).

For added safety in wet conditions, special glass plates are available for public areas with special anti-slip application (DIN 51130 R 11-compliant).

Avoid contact with corrosive chemicals, substances and materials. Read the assembly instructions carefully before beginning with installation or maintenance.

D - IN - GROUND LUMINAIRE INSTALLATION

RAVENNA G 220 or PALERMO G 220 for 5 tonne loads.

The luminaire installs from above in the tree grate and forms a uniform transition with the tree-grate's surface.

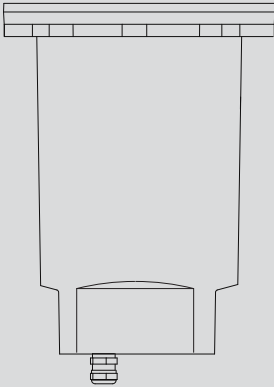

Connecting lead

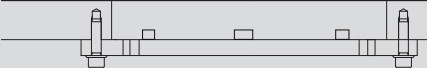

Tree grate
Steel flange

D-IN-GROUND LUMINAIRE INSTALLATION

PESARO B HP for 1 tonne loads.

The luminaire installs from above in the tree grate and forms a uniform transition with the tree-grate's surface.

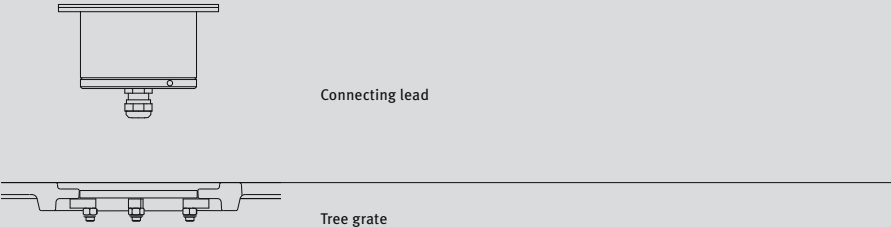

CANTILEVER TREE GRATE SYSTEM

The tree grate system spans the earth around the tree, preventing the ground from becoming compacted.

APPLIES TO:

VERONA 3 T - D
PICENO 3 T - D
MARINO 3 T - D
PADOVA 3 T - D
VINCENZE 3 T - D
MONZA 1.5 T - D
REGULUS 5 T - D
OCTA 5 T - D
SERPO Q 5 T - D
SERPO R 5 T - D

CANTILEVER FRAMES

The two-part construction bolts to concrete foundation and enables:

- Easy paving
- Completion of adjacent earth work and surfacing
- Planting after the completion of construction work
- Installation of the tree grates after the completion of construction work

CONCRETE FOUNDATIONS

Protect the ground around the tree roots from becoming compacted. Designed for the respective tree grate's size and form, the foundations have a single-component construction with notched openings to allow the growth of roots. Fitted with threaded studs for frame attachment. Choice of 260 mm or 400 mm height.

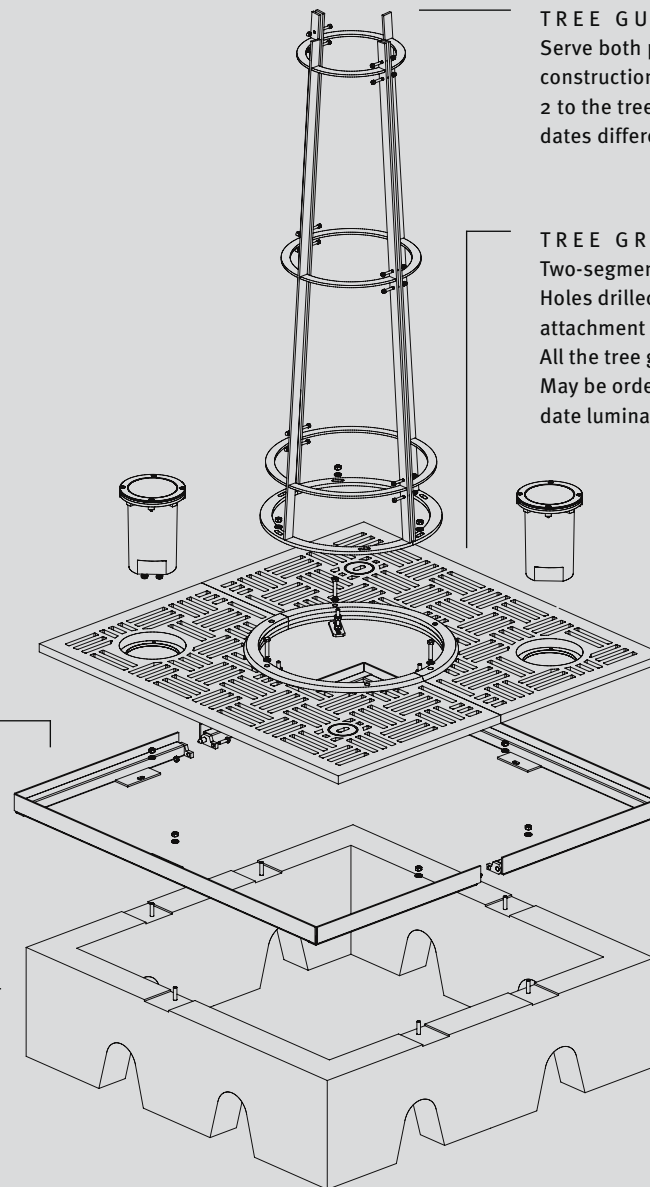

TREE GUARDS

Serve both protective and decorative functions. Two-part construction bolts together and fastens with Screw Set 2 to the tree grate. Grade compensation easily accommodates differences of up to 3%.

TREE GRATES

Two-segment construction sits unfastened in the frame. Holes drilled into the inner rim of the grates permit the attachment of any Hess tree guard. All the tree grates come with watering holes and covers. May be ordered with openings and hardware to accommodate luminaires.

- A Outer measurement of frame
- B Grate opening size
- C Outer measurement of concrete foundation
- D Fastening reference
- E Inlay depth of the grate in the frame
- H Installation height of the frame incl. cast grate
- S Width of grate slits

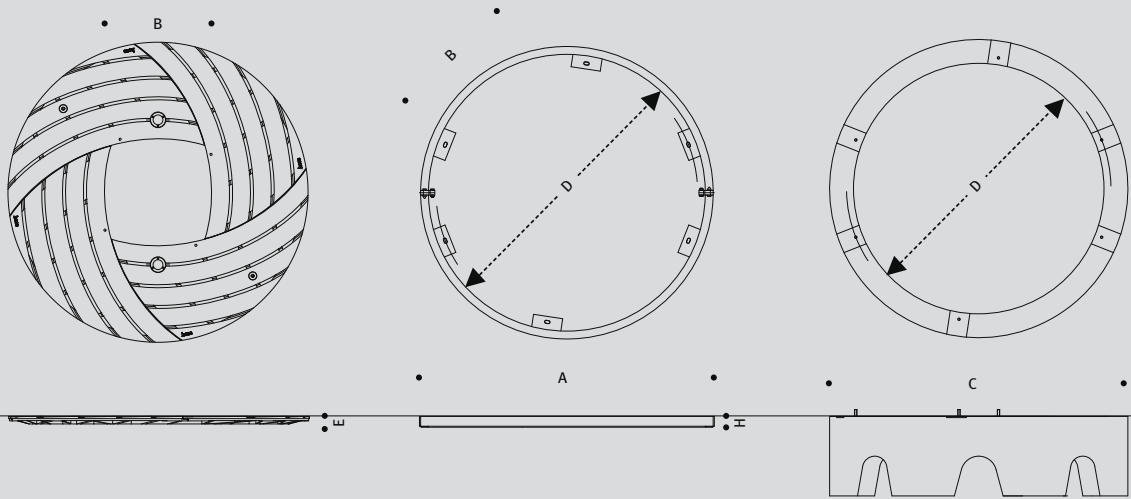
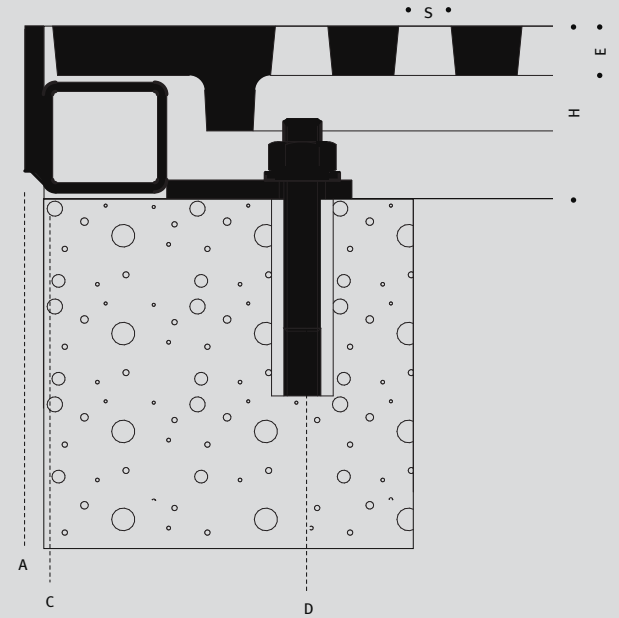

PICENO VARIO BEARING TREE GRATE SYSTEM

TREE GRATES

May consist of one or more segments, which sit unfastened in the frame. The PICENO VARIO tree grate system may be ordered with watering holes and covers, openings and fittings for in-ground luminaires, or a combination of both.

OUTER FRAMES

Frame-within-a-frame construction includes outer and inlay frame, both in two different sizes. The frames configure as required and bolt together. Use of U elements adds design versatility.

The innovative construction enables:

- Easy paving
- Completion of adjacent earth work and surfacing
- Planting after the completion of construction work
- Installation of the tree grates after the completion of construction work

CONCRETE FOUNDATIONS

Since the PICENO VARIO is variable, prefab foundations are of little use. Footings provided by others are the best solution.

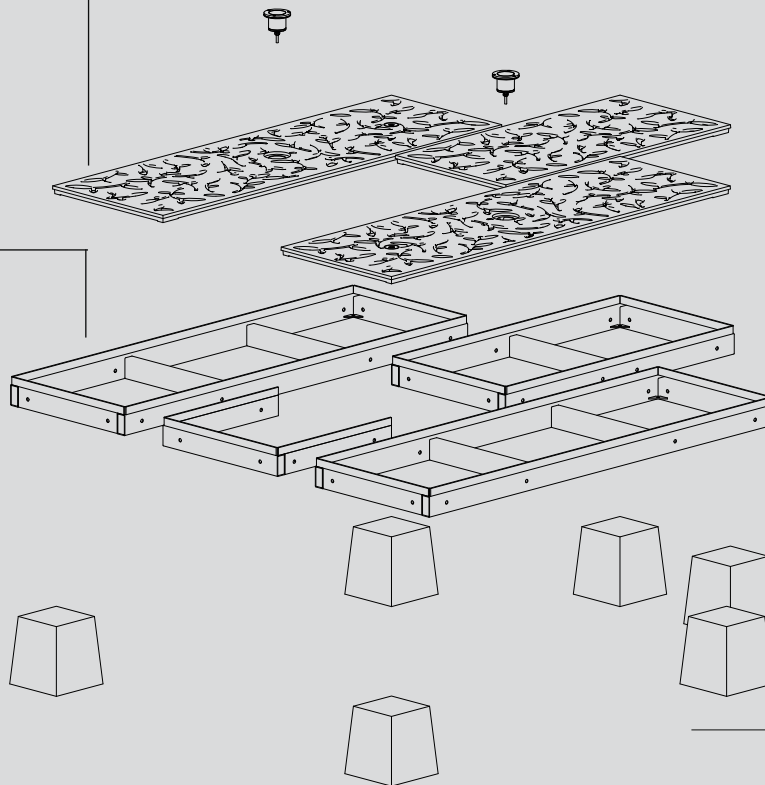

Order No.	Nominal Dimensions	Dimensions in mm	
		A	H
30.43200.0	1200	1200	110
30.43200.1	1800	1800	110
30.43200.2	U element	600	110

A Outer measurement (+ 5 mm tolerance)
H Frame height, incl. grate

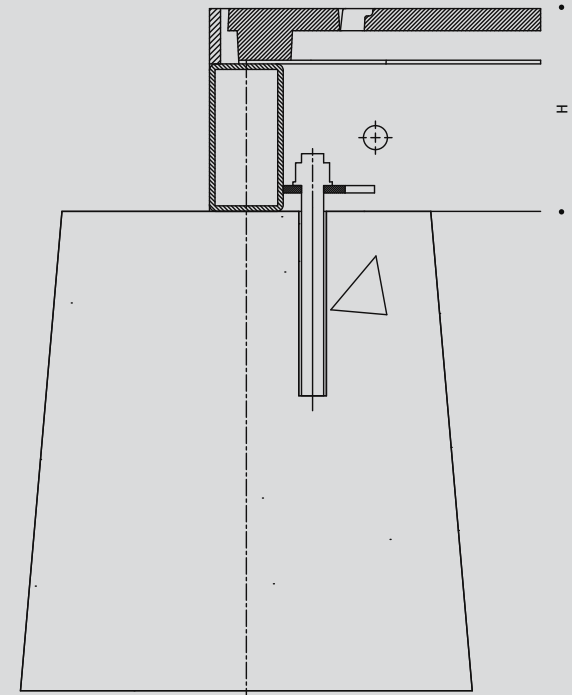

The PICENO VARIO bearing tree grate system's frame is constructed from galvanised flat steel and steel section elements, which bolt together. The outer frames permit the adjacent surface work to be completed before the inlay frame and segments are installed.

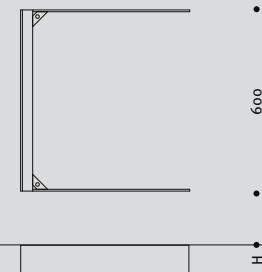
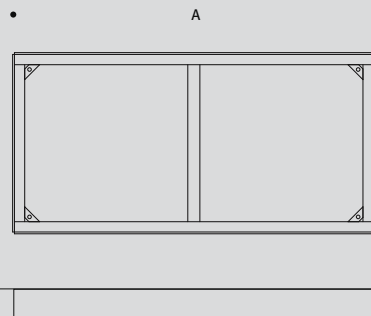
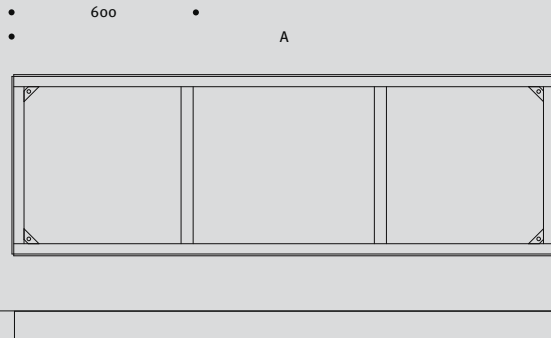

D-LEVEL 2 CANTILEVER FRAME

Cantilever round or square frame constructed from galvanised flat steel and steel section.
Includes two-part outer frame, which allows surface work to be performed adjacent to the tree grate before the inlay construction is installed. Fitted for mounting to Hess concrete foundations.

Order No.	Nominal Dimensions	Dimensions in mm	
		A	H
30.41110.1	Q 1000	1000	70
30.41200.1	Q 1500	1500	70
30.43101.0	Q 1580	1580	70
30.41220.4	Q 2000	2000	70
30.41110.0	R 1000	1000	70
30.41200.0	R 1500	1500	70
30.41220.6	R 2000	2000	70

Order No.	Nominal Dimensions	Dimensions in mm		
		A	D	H
30.43200.0	1200	1200	600	110
30.43200.1	1800	1800	600	110
30.43200.2	U element	600	600	110

- A Outer measurement (+ 5 mm tolerance)
- D Fastening reference
- H Frame height, incl. grate

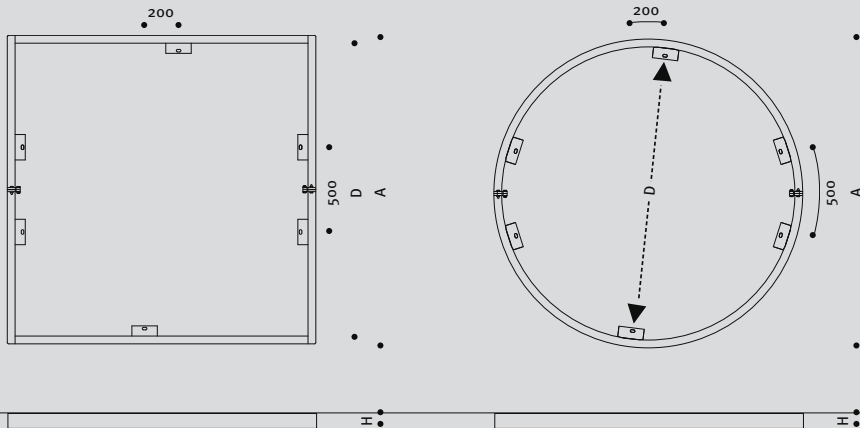

D-LEVEL 2 CONCRETE FOUNDATIONS

Serve as foundations for the steel frame construction in which Hess tree grates are installed. Fitted with threaded studs protruding from the top of the foundation for attachment of the frame. Single-element poured construction. Available in either round or square form and in two heights, 260 and 400 mm. Additional charge: Two-element foundation.

Order No.	Nominal Dimensions	Dimensions in mm	
		C	D
260 mm high			
30.70010.1	Q 1000	990	260
30.70012.1	Q 1500	1490	260
30.70031.0	Q 1580	-	260
30.70020.4	Q 2000	1990	260
400 mm high			
30.70010.0	R 1000	990	260
30.70012.0	R 1500	1500	260
30.70020.6	R 2000	1990	260

Order No.	Nominal Dimensions	Dimensions in mm	
		C	D
400 mm high			
30.70010.3	Q 1000	990	400
30.70012.3	Q 1500	1490	400
30.70031.2	Q 1580	-	400
30.70020.5	Q 2000	1990	400
260 mm high			
30.70010.2	R 1000	990	400
30.70012.2	R 1500	1500	400
30.70020.7	R 2000	1990	400

- C Outer measurement
- D Fastening reference

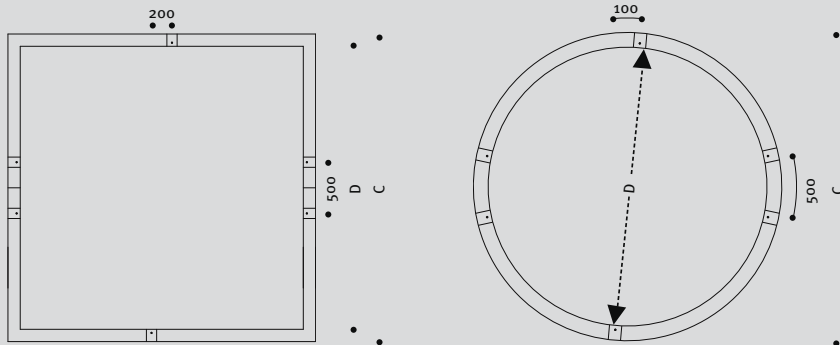

Available in two heights

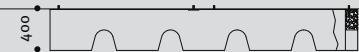
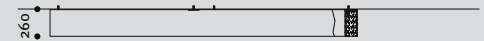

D – CANTILEVER FRAME

Constructed from flat galvanised steel section. Available in square or round shape. Two-part construction bolts together and enables surface work to be performed easily. Fitted for mounting to Hess concrete foundations.

Order No.	Nominal Dimensions	Dimensions in mm		
		A	D	H
30.41200.1	Q 1500	1500	1320	70
30.41201.1	Q 1800	1820	1640	70
30.41202.1	Q 2000	1962	1780	70
30.41203.1	Q 2250	2252	2070	70
30.41200.0	R 1500	1500	1330	70
30.41201.0	R 1800	1820	1620	70
30.41202.0	R 2000	1962	1780	70

- A Outer measurement (+ 5 mm tolerance)
- D Fastening reference
- H Frame height, incl. grate

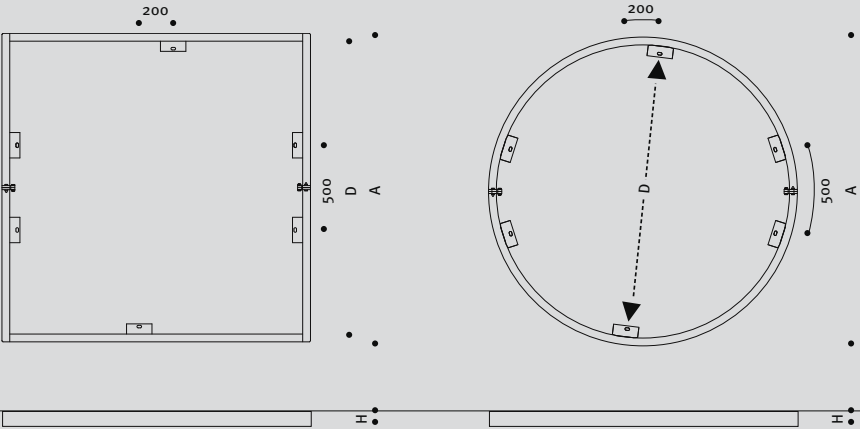

D – CONCRETE FOUNDATIONS

Serve as foundations for the steel frame construction in which Hess tree grates are installed. Fitted with threaded studs protruding from the top of the foundation for attachment of the frame. Single-element poured construction. Available in either round or square form and in two heights, 260 and 400 mm.

Additional charge: Two-element foundation.

Order No.	Order No.	Nominal Dimensions	Dimensions in mm	
			C	D
Height 260 mm	Height 400 mm			
30.70012.1	30.70012.3	Q 1500	1490	1320
30.70013.1	30.70013.3	Q 1800	1810	1640
30.70014.1	30.70014.3	Q 2000	1950	1780
30.70021.0	30.70021.2	Q 2250	2240	2070
30.70025.1	30.70025.3	Q 2500	2505	2335
30.70031.1	30.70031.3	Q 3000	2992	2835

Order No.	Order No.	Nominal Dimensions	Dimensions in mm	
			C	D
Height 260 mm	Height 400 mm			
30.70012.0	30.70012.2	R 1500	1500	1330
30.70013.0	30.70013.2	R 1800	1790	1620
30.70014.0	30.70014.2	R 2000	1950	1820
30.70025.0	30.70025.2	R 2500	2505	2335
30.70030.0	30.70030.2	R 3000	3005	2835

- C Outer measurement
- D Fastening reference

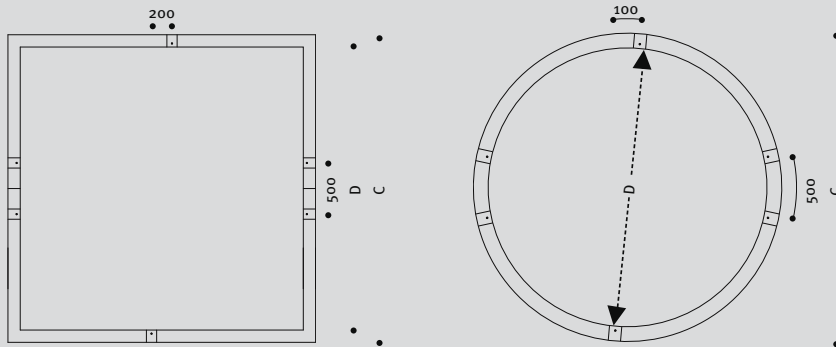

Available in two heights

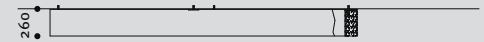

TREE GUARDS

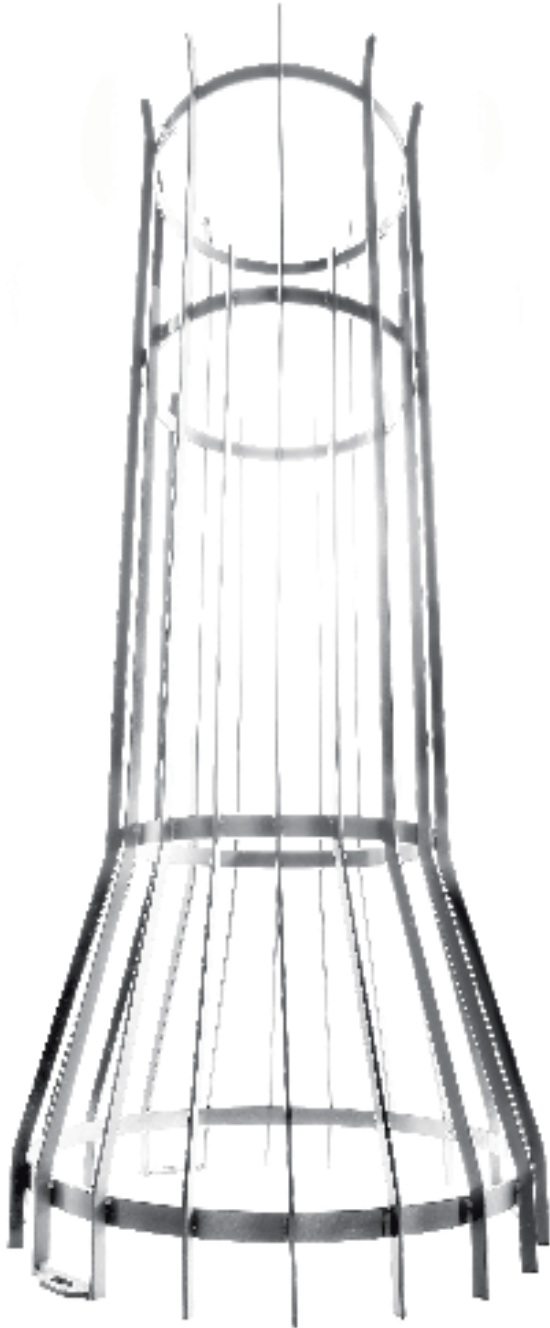

Tree guards are both protective and decorative, underscoring the natural beauty of the trees they serve and perfectly complementing Hess tree grates in function and design.

SCULPO

SCULPO R . Tree Guard . Round

Suitable for all tree grates with round inner openings. Galvanised steel construction bolts to tree grate. Comes with level compensation system. Choice of mica or DB finish.

SCULPO Q . Tree Guard . Square

Suitable for all tree grates with square inner opening. Galvanised steel construction bolts to tree grate. Comes with level compensation system. Choice of mica or DB finish.

Additional charge: Soft or RAL finish.



	Size	Order No.
SCULPO R 1	∅ 620	30.32600.0
SCULPO R 2	∅ 825	30.32600.1
SCULPO Q 1	□ 570	30.32601.0
SCULPO Q 2	□ 840	30.32601.1

Product information
www.hess.eu/o211

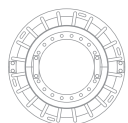

• ∅ 620/∅ 825 •

• ∅ 430/∅ 530 •

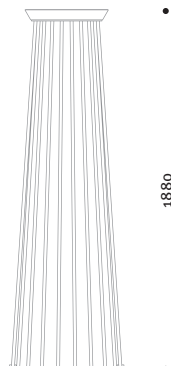

Order No. 30.32600.0

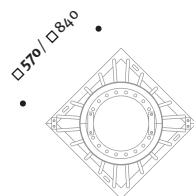

• ∅ 430/∅ 530 •

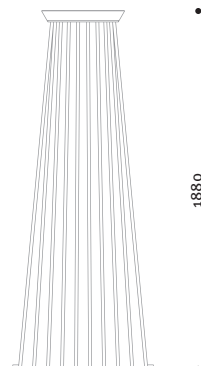

Order No. 30.32601.0



METOR

METOR R . Tree Guard . Round

Suitable for all tree grates with round inner openings. Galvanised steel construction bolts to tree grate. Comes with level compensation system. Choice of mica or DB finish.

METOR Q . Tree Guard . Square

Suitable for all tree grates with square inner opening. Galvanised steel construction bolts to tree grate. Comes with level compensation system. Choice of mica or DB finish.

Additional charge: Soft or RAL finish.



	Size	Order No.
METOR R 1	∅ 620	30.32700.0
METOR R 2	∅ 825	30.32700.1
METOR Q 1	□ 570	30.32701.0
METOR Q 2	□ 840	30.32701.1

Product information
www.hess.eu/o205



• ∅ 610/∅ 815 •

∅ 370/∅ 460

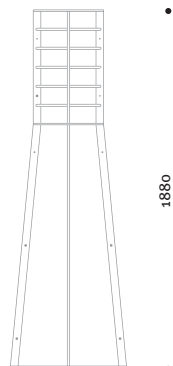

Order No. 30.32700.0

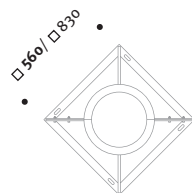

□ 560/□ 830

∅ 370/∅ 460

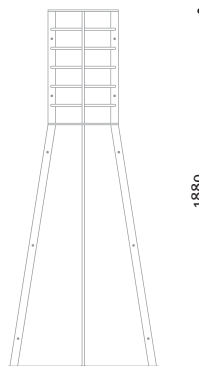

Order No. 30.32701.0

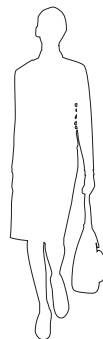

WEGA

WEGA . Tree Guard . Round

Suitable for all tree grates with round inner openings. Galvanised steel construction bolts to tree grate. Comes with level compensation system. Choice of mica or DB finish.

Additional charge: Soft or RAL finish.



	Size	Order No.
WEGA R 1	Ø 620	30.32100.0
WEGA R 2	Ø 825	30.32101.0

Product information
www.hess.eu/o233

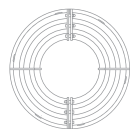

• Ø 610 / Ø 815 •

Ø 290 / Ø 495

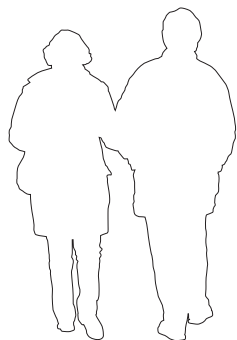
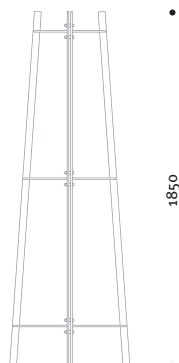

Order No. 30.32100.0

ALGARVE

ALGARVE R . R K . Tree Guard . Round

Suitable for all tree grates with round inner openings. Galvanised steel construction bolts to tree grate. Comes with level compensation system. Choice of mica or DB finish.

ALGARVE Q . Tree Guard . Square

Suitable for all tree grates with square inner opening. Galvanised steel construction bolts to tree grate. Comes with level compensation system. Choice of mica or DB finish.

Additional charge: Soft or RAL finish.



	Size	Order No.
ALGARVE R 1	∅ 620	30.31001.0
ALGARVE R 2	∅ 825	30.31002.0
ALGARVE RK 1	∅ 620	30.31101.0
ALGARVE RK 2	∅ 825	30.31102.0
ALGARVE Q 1	□ 570	30.31301.0
ALGARVE Q 2	□ 840	30.31302.0

Product information
www.hess.eu/o210

Algarve R

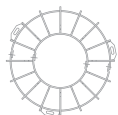

• ∅ 567/∅ 777 •

∅ 278/∅ 488
 • •

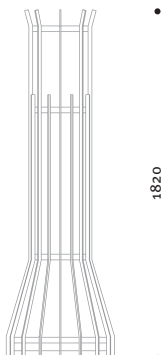

Order No. 30.31001.0

Algarve RK

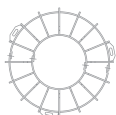

• ∅ 567/∅ 777 •

1375

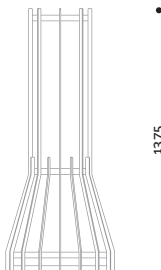

Order No. 30.31101.0

Algarve Q

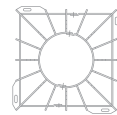

• 527/777 •

∅ 278/∅ 488
 • •

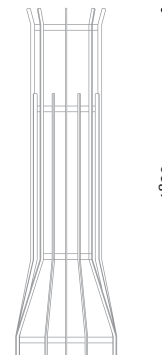

Order No. 30.31301.0





METOR
DONAUSTAUF . GERMANY



SCULPO
BAUTZEN . GERMANY

TREE GUARDS

SCULPO

R1

R2

Q1

Q2



METOR

R1

R2

Q1

Q2



LEVEL 2

PICENO



1500 Q1500 / R620
2000 Q2000 / R825

●

-

-

-

●

-

-

-

MARINO



1000 Q1000 / Q300
1500 Q1500 / Q620
2000 Q2000 / Q825

-

-

-

-

-

-

-

-

●

-

-

-

●

-

-

-

-

●

-

-

-

●

-

-

VINCENZE



1000 Q1000 / R300
1500 Q1500 / R620
2000 Q2000 / R825

-

-

-

-

-

-

-

-

●

-

-

-

●

-

-

-

-

●

-

-

-

●

-

-

MONZA



1580 Q1580 / Q474

-

-

●

-

-

-

●

-

WEGA

R1 R2



ALGARVE

R1 R2 RK1 RK2 Q1 Q2



•	-	-	-	-	-	-	-
-	•	-	-	-	-	-	-
-	-	-	-	-	-	-	-
•	-	-	-	-	-	-	-
-	•	-	-	-	-	-	-
-	-	-	-	-	-	-	-
•	-	-	-	-	-	-	-
-	•	-	-	-	-	-	-
-	-	-	-	-	-	-	-

SCULPO

R1

R2

Q1

Q2



METOR

R1

R2

Q1

Q2



D



REGULUS

		R1	R2	Q1	Q2	R1	R2	Q1	Q2
1500	Q1500 / Q570	-	-	●	-	-	-	●	-
1800	Q1800 / Q570	-	-	●	-	-	-	●	-
2000	Q2000 / Q840	-	-	-	●	-	-	-	●

OCTA



		R1	R2	Q1	Q2	R1	R2	Q1	Q2
1500	Q1500 / Q570	-	-	●	-	-	-	●	-
1800	Q1800 / Q570	-	-	●	-	-	-	●	-
2000	Q2000 / Q840	-	-	-	●	-	-	-	●

SERPO Q



		R1	R2	Q1	Q2	R1	R2	Q1	Q2
1500	Q1500 / R620	●	-	-	-	●	-	-	-
1800	Q1800 / R620	●	-	-	-	●	-	-	-
2000	Q2000 / R825	-	●	-	-	-	●	-	-

SERPO R



		R1	R2	Q1	Q2	R1	R2	Q1	Q2
1500	R1500 / R620	●	-	-	-	●	-	-	-
1800	R1800 / R620	●	-	-	-	●	-	-	-
2000	R2000 / R825	-	●	-	-	-	●	-	-

WEGA

R1 R2



ALGARVE

R1 R2 RK1 RK2 Q1 Q2



-	-	-	-	-	•	-
-	-	-	-	-	•	-
-	-	-	-	-	-	•
-	-	-	-	-	•	-
-	-	-	-	-	•	-
•	-	•	-	-	-	-
•	-	•	-	-	-	-
-	•	-	•	•	-	-
•	-	•	-	-	-	-
•	-	•	-	-	-	-
-	•	-	•	•	-	-



CAST GRATING AND COVERS



Today, Hess continues its long tradition of providing custom cover and grating solutions for every possible street and site application.

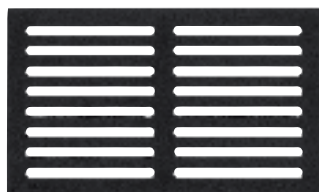

F E R M O

Street Gutter and Lighting Well Cover
www.hess.eu/0510

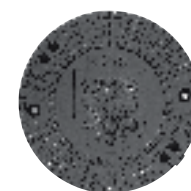
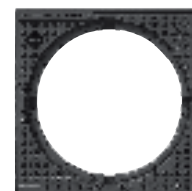

K U F R A

Manhole Cover . Wheel load capacity up to 5 t
www.hess.eu/0580

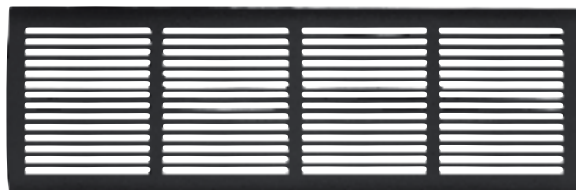

A M B O N

Trench Grate
www.hess.eu/0555

